

dCS Vivaldi Upsampler
Digital to Digital Converter

User Manual
Software Release 2.1x
August 2019

Part No: DCS401653 V02

© **Data Conversion Systems Ltd. 2012 - 2019**

All rights reserved. No part of this publication may be reproduced, stored in or introduced into a retrieval system, or transmitted in any form, or by any means (electronic, mechanical, photocopying, recording or otherwise) without the prior written permission of *dCS*¹. Any person who does any unauthorised act in relation to this publication may be liable to criminal prosecution and civil claims for damages.

Information contained in this manual is subject to change without notice, and whilst it is checked for accuracy, no liabilities can be accepted for errors.

¹ *dCS* is Data Conversion Systems Ltd. Company registered in England No. 2072115.

Contents

Using the dCS Vivaldi Upsampler for the first time	5
What's in the box?	5
dCS Mosaic	5
Positioning the unit	6
Important Safety Instructions	6
Safety Notice	7
Made for iPhone® and iPad®	8
Step-by-Step Guide	9
Preliminaries	9
STEP 1 – Connecting a PCM input	10
Connecting to a Single AES or SPDIF source	10
Connecting to an SDIF-2 PCM Source	10
STEP 2 – Connecting an Output	11
Dual AES	11
Single wire PCM	12
STEP 3 - Setting the Sync Mode	13
Using a Master Clock	13
Using the Vivaldi Clock's enhanced clocking system	13
A full Vivaldi system	14
STEP 4 – Using the USB1 interface with a computer	15
Compatibility	15
Setting the USB Audio Class	15
Loading the Windows driver for USB Class 2	15
Basic setup with a PC	16
A word about Music Playing Software	16
Selecting the Vivaldi Upsampler as your Audio Output device	17
STEP 5 – dCS Mosaic Network Connection	18
Basic set-up	18
Playing music with AirPlay	19
Using the Vivaldi Upsampler with Spotify Connect	19
Using the Vivaldi Upsampler with Tidal, Qobuz, Deezer and Internet Radio	19
Using the Vivaldi Upsampler with Roon	19
Playing MQA files	20
STEP 6 - Using the dCS Mosaic Control as a remote control	21
STEP 7 – Using the USB2 input	22
STEP 8 – Setting the Sync Mode for Computer Audio sources	23
Using the DAC in Universal Master Mode	23
Using the DAC and Upsampler with a Master Clock	24
Advanced options	25
Using the Web Client interface	25
Customising the input configuration	26
Front Panel	27
Remote Control Receiver	27
Display – dCS Mosaic	27
Control Modes	28
Power Button	28
Menu Button	28
Filter Button	29
Input Button	30
Output Button	30
Rear Panel	31
Digital Outputs	31
Digital Inputs	31
Word Clock Input / Output	32
Network Interface	32
USB Interfaces	33
Test interface	33
Mains inlet	33
Label	33

The Menu	34
Using the Menu	35
INFORMATION Menu	36
Unit Status	36
Version	36
Contact	36
Update	36
UPSAMPLER SETTINGS Menu	37
Sync Mode	37
Dual AES	37
Clone Mode	38
USB Class	38
DSD Pass-Through	38
DXD Mode	39
EasyPlay	39
RS232 Mode	39
CONFIGURATION Menu	40
Settings Lock	40
Save Configuration	40
Restore Configuration	40
Reset Input Names	40
Factory Reset	40
DISPLAY SETTINGS Menu	41
Brightness	41
Display On/Off	41
GENERATOR Menu	41
Channel Check	41
Phase Check	41
Burn In	41
Configuration with Mosaic Control.....	42
Specification	43
Maintenance and Support.....	45
Service and Maintenance	45
Replacing a Blown Mains Fuse	45
Cleaning the case	45
Limited Warranty	46
If you need more help	47
Software History	48
Software update	49

USING THE *dCS* VIVALDI UPSAMPLER FOR THE FIRST TIME

Congratulations on purchasing your *dCS* Vivaldi Upsampler.

Before using your unit, please read this section and the Step by Step Guide. This will enable you to set the unit up quickly and safely with your hi-fi system.

From time to time, *dCS* will release updated software that you can install yourself using the *dCS Mosaic Control*. Please check our web-site occasionally to see if new Vivaldi Upsampler software is available, or consult your dealer.

What's in the box?

Check that the box contains the following items:

- *dCS* Vivaldi Upsampler
- Manual and Menu Guide
- *dCS Mosaic Control* Quick Reference Guide
- Power cable
- 2 AES cables
- USB-A to USB-B cable
- Ethernet cable
- BNC cable
- 3-way RS232 cable
- Spare fuses
- Spotify flyer

Notify your dealer as soon as possible if anything is missing or damaged. We suggest that you retain the original packaging for possible future use. If this is not possible, replacement packaging can be ordered from *dCS* or our distributors. Details can be found on our web site at www.dcsLtd.co.uk.

The Vivaldi Upsampler is intended to be controlled by *dCS Mosaic Control* (see below) over an ethernet network.

A *dCS* remote control is supplied with the **Vivaldi DAC**, it is available as an optional extra.

dCS Mosaic

dCS Mosaic is a carefully assembled collection of hardware and software modules which provide easy and intuitive access to a vast catalogue of digital music. Whether it's high resolution files on a local server or an internet radio station broadcast from a distant land, *dCS Mosaic* ensures that the music you love is only a few convenient taps away. *dCS Mosaic* comprises of three parts.

dCS Mosaic is the name for the audio streaming and networked control functionality of *dCS* products.

dCS Mosaic Control is the name of the iOS and Android software application for music management and product control.

dCS Mosaic Processor is the physical hardware component and associated software that is installed in the *dCS* product to provide streaming functionality.

Please refer to the *dCS Mosaic Control* Quick Reference Guide for further information.

Positioning the unit

For best sound quality, the units in the Vivaldi range are designed to be mounted on separate shelves of a rack, although they may be stacked directly on top of each other if this is absolutely necessary. Place each unit on a firm, vibration free base, allowing convenient connection to the other parts of your system. To prevent overheating, we recommend that you leave some free space around the unit to allow for ventilation.

The unit is supplied with 4 feet fitted. If you prefer a 3-feet layout, unscrew the two back feet, remove the two black cores using a 2.5mm A/F Allen key, fit one of the cores in the middle position and replace the foot. Take care not to cross-thread the foot!

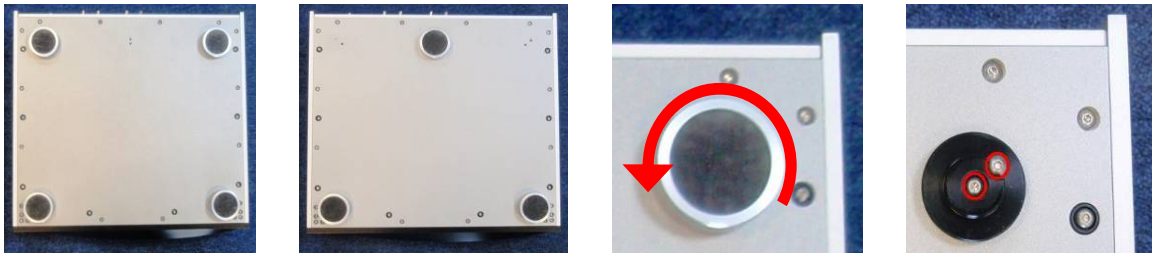

With all feet screwed fully home, the unit will sit level on a flat surface. If you need to do any levelling, you can unscrew any of the feet up to 3 complete turns, to give up to 3mm (1/8") of height adjustment.

Important Safety Instructions

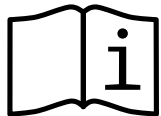

The following statements are required to comply with U.S. safety standard UL60065.

- Read these instructions.
- Keep these instructions.
- Heed all warnings.
- Follow all instructions.
- Do not use this apparatus near water.
- Clean only with dry cloth.
- Install in accordance with the manufacturer's instructions.
- Do not install near any heat sources such as radiators, heat registers, stoves, or other apparatus (including amplifiers) that produce heat.
- Do not defeat the safety purpose of the grounding-type plug. A grounding type plug has two blades and a third grounding prong. The third prong is provided for your safety. If the provided plug does not fit into your outlet, consult an electrician for replacement of the obsolete outlet.
- Protect the power cord from being walked on or pinched particularly at plugs, convenience receptacles, and the point where they exit from the apparatus.
- Only use attachments/accessories specified by the manufacturer.
- Unplug this apparatus during lightning storms or when unused for long periods of time.
- Refer all servicing to qualified service personnel. Servicing is required when the apparatus has been damaged in any way, such as power-supply cord or plug is damaged, liquid has been spilled or objects have fallen into the apparatus, the apparatus has been exposed to rain or moisture, does not operate normally, or has been dropped.

Safety Notice



In the event of the unit developing a fault, please contact your dealer in the first instance.

If you decide to remove safety covers for any reason, disconnect the power cable first. Note that removing covers voids the warranty.

To maintain protection from electric shock, the unit **MUST** be connected to mains earth (ground) via the power cable. Also, unearthed systems do not give the best sonic performance.

Protect the product from dripping or splashing liquids. Liquid-filled objects such as vases must not be placed on the product.



This product is not suitable for operation at altitudes above 2000m.



This product is lead-free and complies with the RoHS directive.

Before connecting the power cable to the unit for the first time, please check that it has been set to the correct operating voltage for your mains supply. The unit's voltage setting is shown on the serial number label. If this does not match your local supply voltage, **DO NOT** attempt to use the unit. Contact your dealer to have the unit reset. Using the unit with the wrong mains setting for your local supply may result in serious damage to the unit and will invalidate the warranty. Do not attempt to reset the voltage yourself.

We do not recommend the use of mains regenerators. However, if you do wish to use a mains regenerator with variable voltage and frequency, we recommend that you set the voltage to match your local voltage and the frequency to either 50Hz or 60Hz **ONLY**.



Damage caused to your Vivaldi Upsampler by misuse of a mains regenerator or by a malfunctioning mains regenerator is not covered by the warranty.



Disposal at end-of-life - the symbol indicates that this product should not be treated as normal household waste. It should be recycled, so please take it to an approved collection facility.

Made for iPhone® and iPad®

The Vivaldi Upsampler is compatible with the iPhone and iPad models illustrated below.
Made for:



iPhone 6 Plus
16GB 64GB 128GB



iPhone 6
16GB 64GB 128GB



iPhone 5
iPhone 5c iPhone 5s
16GB 32GB 64GB



iPad Air
16GB 32GB 64GB 128GB

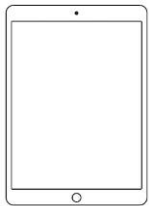

iPad Air 2
16GB 64GB 128GB



iPad mini
iPad mini 2
16GB 32GB 64GB 128GB



“Made for iPod” and “Made for iPhone” mean that an electronic accessory has been designed to connect specifically to iPod or iPhone respectively and has been certified by the developer to meet Apple performance standards. Apple is not responsible for the operation of this device or its compliance with safety and regulatory standards.

iPad®, iPhone, iPod and iPod touch® are trademarks of Apple Inc., registered in the U.S. and other countries.

STEP-BY-STEP GUIDE

This section guides you through setting up the unit for use in various ways.

Preliminaries

The Menu Guide sheet details the menu structure.

For digital interfaces, use with cables designed for digital audio:

- for AES/EBU interfaces use 110Ω screened, twisted pair cables fitted with one male XLR connector and one female XLR connector.
- for SDIF, Word Clock or SPDIF BNC interfaces, use 75Ω coax cables fitted with BNC plugs.



SDIF and Word Clock interfaces require a simple DC-coupled connection. The interfaces may malfunction or not work at all if capacitor coupled cables or cables with built-in networks are used.

- for SPDIF RCA interfaces, use 75Ω coax cables fitted with RCA Phono plugs.
- for TOSLINK optical interfaces, use Toslink fibre-optic cables.
- for the Network interface, use the Ethernet cable provided with the unit.
- for the USB1 interface, use a standard screened USB cable fitted with one type 'A' connector and one type 'B' connector. The internal screen must be connected at both ends.
- Connect the power cable to the power inlet on the Upsampler rear panel, and plug the other end into a convenient power outlet. Set the rocker switch on the rear panel to the **I** position (on).



Please do not use an excessively heavy or inflexible power cable as this may damage the power inlet connector.



The cables supplied with the unit are “commercial grade”, because most owners will have their own “audiophile grade” cables or will prefer to make their own cable choices.

- Press the **Power** button – the unit will display **Vivaldi Upsampler**. Wait about 30 seconds while the Upsampler configures itself.
- If the unit is likely to be set in an unfamiliar state, you can run the **Factory Reset** routine by pressing the buttons in this sequence: **Menu**, **▶**, **▶**, **Menu**, **◀**, **◀**, **Menu**.
- Wait a few seconds while the unit resets itself.

We will start with a basic setup using a standard PCM source.

STEP 1 – Connecting a PCM input

Switch on the source equipment. If appropriate, load a disk / tape and set the machine in PLAY mode to ensure it is generating a digital audio data stream.

Choose one or more of the following sections:

Connecting to a Single AES or SPDIF source

Most digital audio source equipment (such as CD transports, DVD players) is fitted with a single wire digital output, usually on an RCA phono connector.

- Connect your source equipment to the matching input on the Upsampler's rear panel using a suitable cable.
- Press the **Input** button repeatedly until your chosen input is displayed. This will be either **AES**, **SPDIF1** (RCA), **SPDIF2** (RCA), **SPDIF3** (BNC) or **Toslink**.

The Upsampler will lock to the source and display **16/44.1 > 96** for example, if the source is a CD player.

Connecting to an SDIF-2 PCM Source



SDIF (**S**ony **D**igital **I**nter**F**ace) is not the same as SPDIF (**S**ony/**P**hilips **D**igital **I**nter**F**ace) and the two are not compatible. Please ensure that you connect to the correct BNC socket.

- Connect the CH1 output on your source equipment to the **CH1** input on the Upsampler's rear panel and the CH2 output to the **CH2** input, using two BNC cables. Connect the word clock output on your source equipment to the **Word Clock In1** or **In2** connector on the Upsampler's rear panel. Ensure the cables are not swapped.
- Press the Upsampler's **Input** button repeatedly until **SDIF** appears on the display.



Set the **Settings > Sync Mode** menu page to **Word Clock 1** or **Word Clock 2** as appropriate.

The Upsampler will lock to the source and display **16/44.1 > 96** for example, if the source is a CD player.

STEP 2 – Connecting an Output

Choose which output interface you want to use and connect it up as described below. The Upsampler's main output is **Dual AES**. You can connect as many outputs as you wish.

Dual AES

Connect the **AES1 Out** and **AES2 Out**puts to matching inputs on your DAC. Use the **Output** button on the front panel to set the output sample rate to 88.2, 96, 176.4, 192, 352.8 or 384kS/s or DSD or DSDx2.



Open the menu, scroll to the **Settings > Dual AES** page and make sure it is set to **On**. (The button sequence is **Menu, ►, Menu, ►**.) If it is not, press the **Menu** button once.

Use the DAC's **Input** button to select the **Dual AES** input. You may need to open the DAC's menu and set it to accept Dual AES.



All dCS DACs are capable of Dual AES operation, older models may be limited to a maximum of 192kS/s. Some other manufacturer's DACs may have 2 single AES inputs that are not Dual AES capable. Please check the DAC manual to be sure.

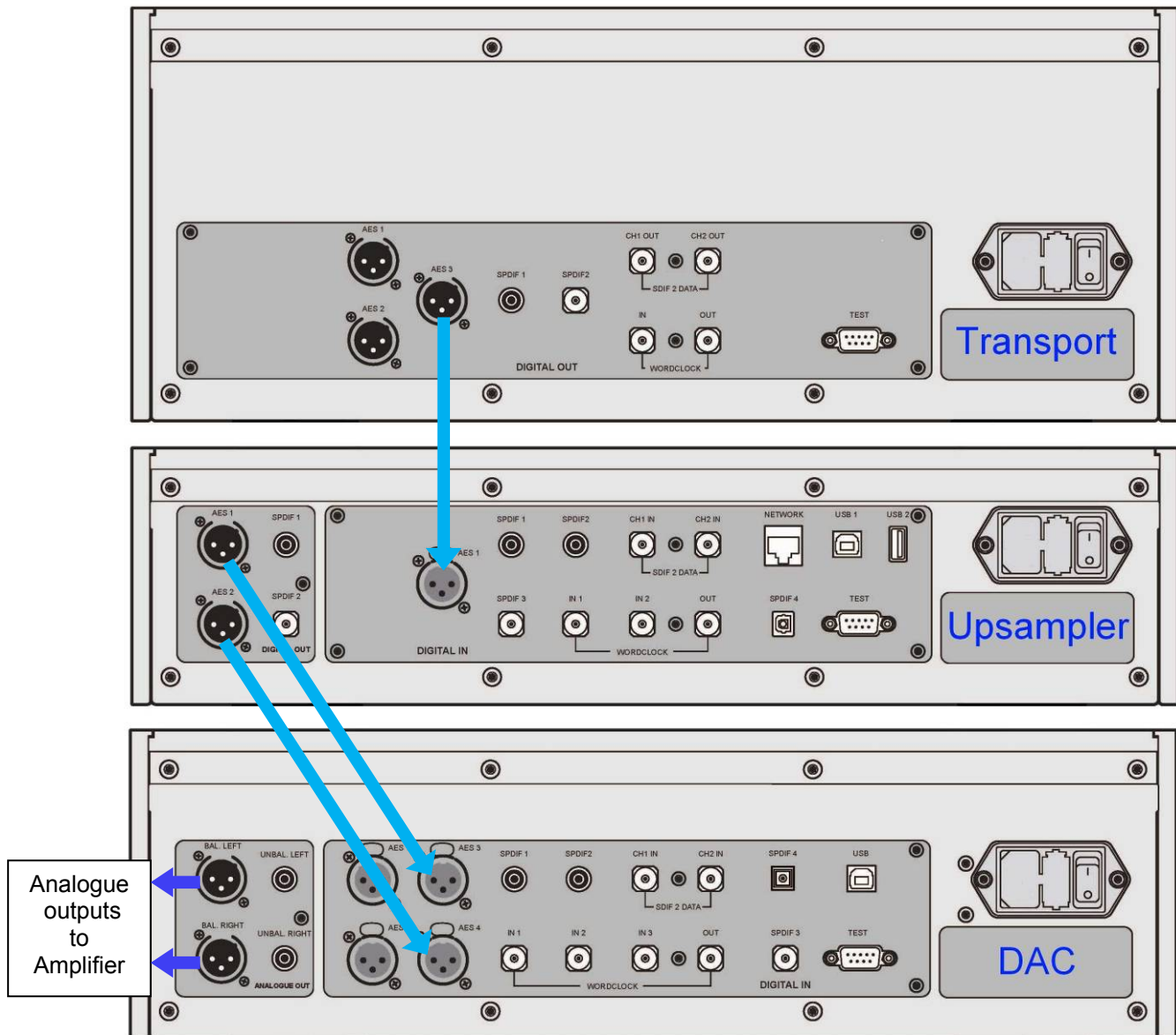

Figure 1 – Connecting the Dual AES output

Single wire PCM

Connect one or more of the PCM outputs (**AES1 Out**, **AES2 Out**, **SPDIF1 Out**, **SPDIF2 Out**) to matching inputs on your DAC. Use the **Output** button on the front panel to set the output sample rate to 32, 44.1, 48, 88.2, 96, 176.4 or 192kS/s or DSD or DSDx2.



If you want to use the **AES1** and **AES2** outputs in single-wire mode, open the menu, scroll to the **Settings > Dual AES** page and make sure it is set to **Off**. (The button sequence is **Menu**, **▶**, **Menu**, **▶**.) If it is not, press the **Menu** button once.

Use the DAC's **Input** button to select that input.



If the output sample rate is **352.8** or **384** or **DSDx2**, the two SPDIF outputs will be muted and the two AES outputs will automatically be set to Dual AES mode.

The Upsampler will not output sample rates that are lower than the input sample rate.

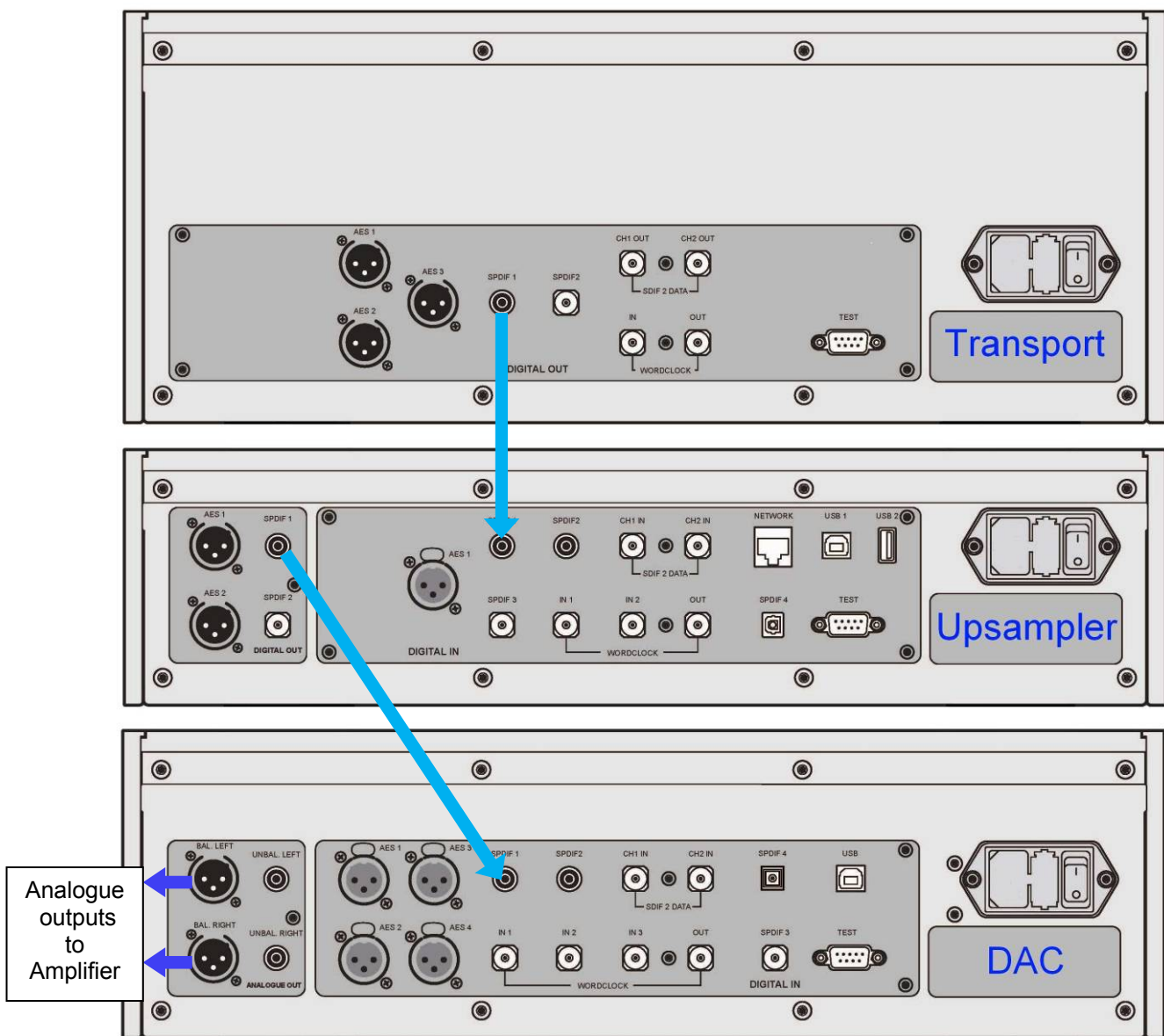

Figure 2 – Connecting a single-wire SPDIF output

Connect the DAC's outputs to the amplifier & speakers. Start the source playing and set the DAC's Volume control to a comfortable level. You should have audio at this point.

Go to STEP 3.

STEP 3 - Setting the Sync Mode



If the Upsampler was reset at the start of this procedure and you have selected the **AES** or an **SPDIF** input, you should see the **Sync Mode - Audio** icon. The system has been set up to lock to the clock generated by the source.

This is the simplest arrangement, but it does not give the best sonic performance due to clock jitter. You can improve the performance by adding a Master Clock to your system.

Using a Master Clock

If you have a Vivaldi Clock (or other dedicated Clock) in your system, lock the source, the Upsampler and the DAC to the Clock for the best performance. To do this:

- Connect the one of the Clock's **Group 1 Word Clock Outputs** to the **Word Clock In 1** connector on the source, Upsampler and DAC.
- Set the Clock **Frequency 1** to suit the source and DAC. For a CD Transport as source with the Upsampler set to output **176.4**, **352.8**, **DSD** or **DSDx2**, a suitable frequency is **44.1kHz**. For a 48kS/s source (such as a DVD player) with the Upsampler set to output **192** or **384**, a suitable frequency is **48kHz**.
- Select the required input on the Upsampler and DAC. This is important because these units store a different **Sync Mode** setting for each input.



To set the Upsampler to lock to the Clock, open the menu, scroll to the **Settings > Sync Mode** page and check it is set to **Word Clock 1**. (The button sequence is **Menu**, **▶**, **Menu**.) If it is not, press the **Menu** button as necessary until the **W1** icon is displayed.

- When the menu has closed, the Upsampler will display the **W1** icon, provided the clock is recognised.



If there is no signal at the **Word Clock In1** connector or it is not recognisable, the Upsampler will sync to audio and display this icon to warn you.

- The Vivaldi Transport will automatically lock to the Clock and display a **W** icon.
- Set the Vivaldi DAC to sync to Word Clock in a similar way to the Upsampler.

Using the Vivaldi Clock's enhanced clocking system

You may have noticed that the Vivaldi Upsampler has 2 Word Clock inputs, and the Vivaldi DAC has 3. **Word Clock In1** and **In2** are intended to be used together for ease of use in situations where the sample rate of the source often changes. Computer audio is an obvious example of this (the files on our server were recorded at 10 different sample rates), another example is cycling through the Upsampler's output rates to find the best sound. *dCS* products have featured clock multiplication for several years, but it is much more difficult to keep the clock free from jitter when you change from 44.1 / 88.2 / 176.4 to 48 / 96 / 192.

So the Vivaldi Clock's outputs are split into 2 groups, the idea is that one group is set to 44.1kHz (or a multiple) while the other is set to 48kHz (or a multiple). A Word Clock connection from each group connects to **Word Clock In1** and **In2** of both the Upsampler and DAC.



First, select the input you want to lock to the Clock. Then set the **Settings > Sync mode** menu page in each unit to **Auto W1/W2**, and both units will automatically choose the clock that is synchronous with the data.



If you are using the Transport also, don't forget to connect one of the Clock's 44.1kHz outputs to the Transport's **Word Clock Input!**

A full Vivaldi system

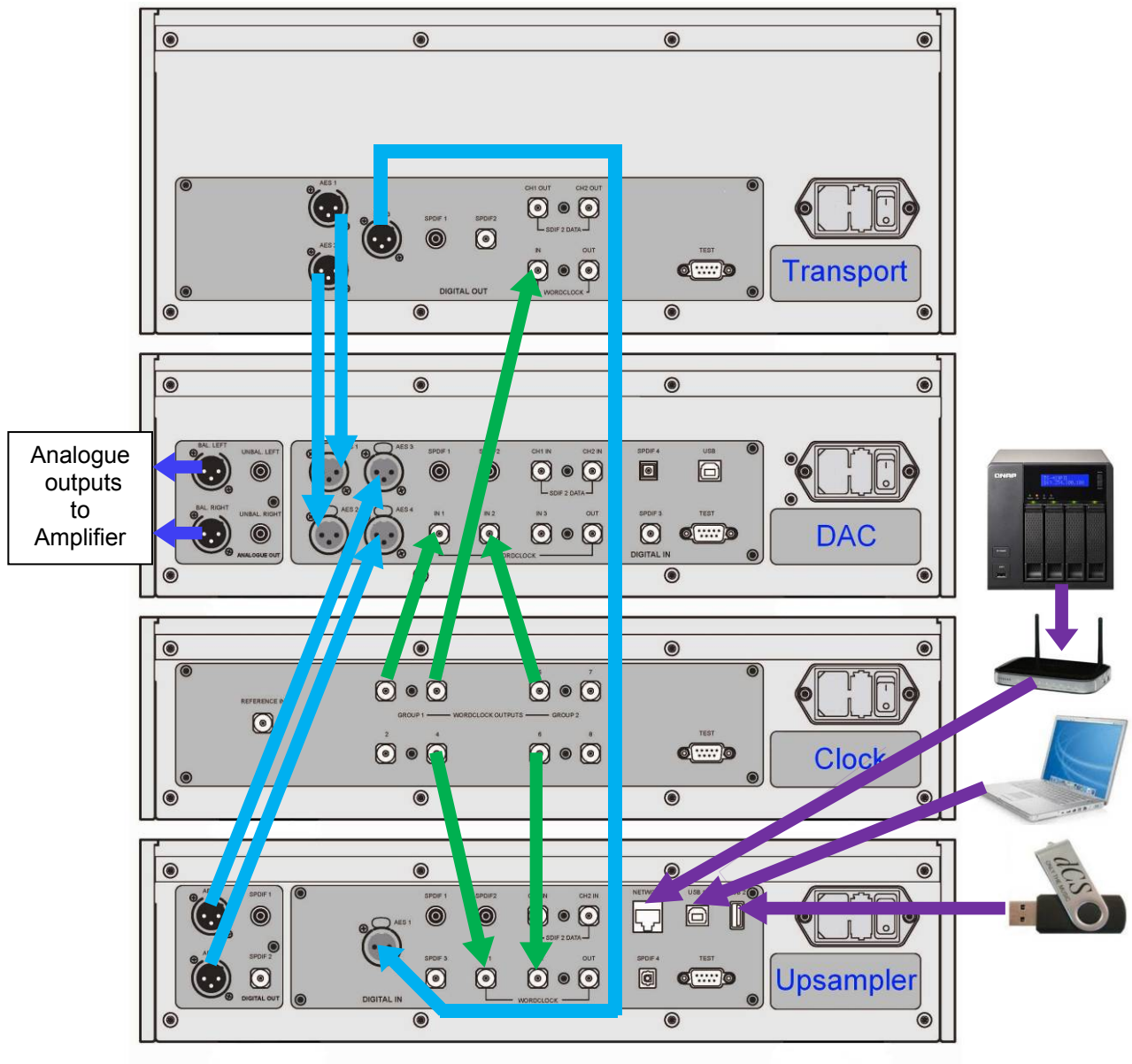

Figure 3 – A 4-box Vivaldi system plus computer audio sources

The following sections detail connection of computer audio sources.

STEP 4 – Using the USB1 interface with a computer

If you do not want to use a computer, you can miss out this step.

Compatibility

The **USB1** interface can be connected to Windows™ 10 / 8.1 / 7, Mac™ OSX (10.5.4 or later) systems or a sound server, running music streaming software.

The interface should work with Linux Ubuntu servers and computers fitted with USB 2.0 interfaces that natively support USB Audio Class 1 or Class 2 operation, but this has not been extensively tested.

Setting the USB Audio Class

There are two USB Audio classes, one of which must be set during system set-up. The Upsampler is shipped set to USB Audio Class 2.

USB Audio Class 1: The interface operates without a special driver at up to 96kS/s.



To select Class 1, open the menu, navigate to the **Settings > USB Class** menu page. The button sequence is: **Menu**, **▶**, **Menu**, **◀**, **◀**, **◀**, **◀**, **◀** and then use the **Menu** button to select the **Class 1** icon.

USB Audio Class 2: The interface operates at up to 384kS/s (including up to DSD/128 as DoP).

For Mac OSX, version 10.6.3 or later is required.

Windows 10 Creator's Edition supports Class 2 operation.

For earlier versions of Windows, the *dCS* USB Class 2 Driver 2018 must be installed onto the computer before use (see below).



To select Class 2, open the menu, navigate to the **Settings > USB Class** menu page. The button sequence is: **Menu**, **▶**, **Menu**, **◀**, **◀**, **◀**, **◀**, **◀**, and then use the **Menu** button to select the **Class 2** icon.



If an older version of the *dCS* USB Class 2 driver is installed on your Windows PC, please un-install it and install the current version.

Loading the Windows driver for USB Class 2

- If ASIO4ALL or any other ASIO driver (e.g. for a sound card) is loaded on your computer, please uninstall it - otherwise the *dCS* driver will not work correctly.
- Power up the Upsampler and the computer.
- Make sure the Upsampler is set to USB Class 2 - otherwise the driver installation will fail.
- Connect the Upsampler's **USB1** port to the computer's USB port.
- Go to <https://www.dcsLtd.co.uk/products/vivaldi-upsampler/support>, then click the **Download** button next to **USB Class 2 Driver 2018**.
- Unzip the file to a temporary directory and run the file.
- Follow the on-screen prompts.
- Wait until installation is complete, then re-start the computer.



If you connect a Vivaldi Upsampler set for USB Audio Class 2 to a Windows computer without first loading the driver, the computer will not be able to find the Upsampler.

Basic setup with a PC

- Connect one of the computer's USB ports to the **USB1** port on the Upsampler's rear panel.
- To select the **USB1** port, either use the **dCS Mosaic Control** app to select the required input or press the **Input** button repeatedly until **USB1** is displayed.



Open the Menu and select **Settings > Sync Mode > Master Mode**.

This is the Upsampler's default **Sync Mode** for the USB and Network interfaces. The Upsampler does not lock to the source clock, but uses the Upsampler's internal clock instead. A control signal is sent back to the source to control the delivery of data bursts from the computer. This arrangement avoids the use of the computer's inaccurate and jittery clock.

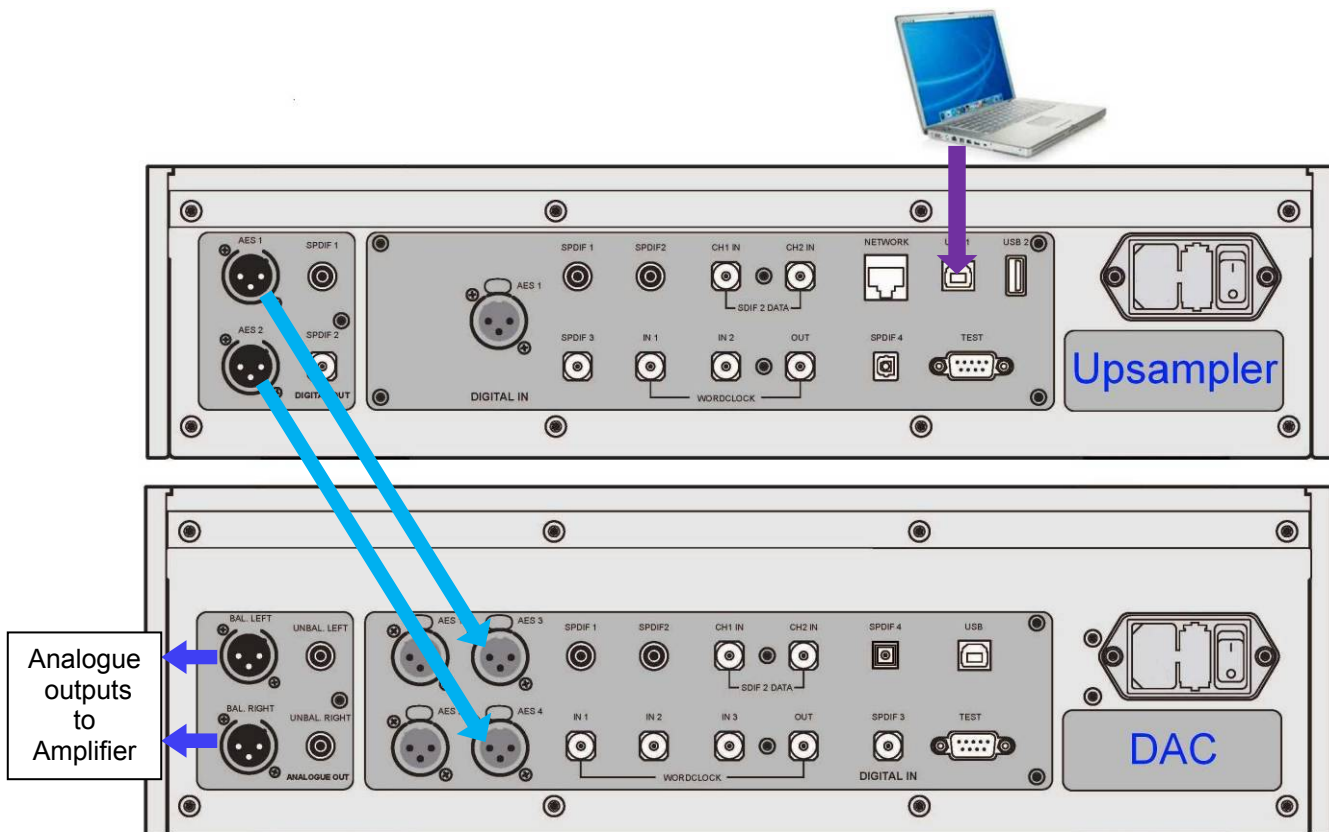

Figure 4 – Using a Vivaldi Upsampler and DAC with a laptop

A word about Music Playing Software

There are countless programs that can play music on Windows and Apple Mac OSX PCs. Unfortunately, not all of them present the data completely unprocessed to the USB ports. For example, Windows Media Player re-samples all data to 24 bits, albeit at the original sample rate, while iTunes rate converts data as necessary to the output sample rate set in the OSX Audio MIDI Set-up panel.

With such a proliferation of playing software, and with updates being issued daily, it is impossible for *dCS* to be fully up-to-date with the behaviour and performance of all programs. If you have questions or problems, we would urge you to take them up with your software vendor. Different programs operate very differently and it is well worth finding out exactly how your particular program processes the audio.

We suggest that you use a premium music streaming program, such as JRiver Media Center (Windows or Mac) or Audirvana (Mac), rather than relying on the software bundled with the operating system.

Selecting the Vivaldi Upsampler as your Audio Output device

Whichever program you are using to play your music, your computer may not automatically select your Vivaldi Upsampler as the preferred playback device. Once you have connected the Upsampler and switched it on, you can correct this as follows:

Mac OSX - Open **Finder**, click on the **Go** tab and select **Utilities > Audio MIDI Setup**. Select **dCS Vivaldi USB ...** from the list on the left-hand side, right-click on it, and choose “**Use this device for sound output**” from the drop down list. Set the **Format** to **384000.0Hz** and **2ch-24bit Integer**. Close **Audio MIDI Setup**.

Windows 10 / 8.1 / 7 - Go to **Start > Control Panel > Hardware and Sound > Sound**. In the **Playback** panel, right-click **dCS Vivaldi Upsampler Audio** and choose **Set as Default Communication Device**. Click the **Enhancements** tab and check **Disable all enhancements**. Select the **Advanced** tab, choose **24 bit, 384000 Hz (Studio Quality)** from the drop-down box. Check the 2 boxes under **Exclusive Mode**, click **OK** and **OK** again to close the **Sound** panel.

Open your streaming program, select the **Vivaldi Upsampler** in the **Options** or **Preferences** panel and play some music.



If the **USB1** input stops responding and cannot be found by the PC, it may be that the USB firmware has been corrupted. This can happen if the USB connection is not secure while playing a track. Disconnect the USB cable, change the **Settings > USB Class** setting, then change it back and re-connect the USB cable. This will usually solve the problem.

Go to STEP 5.

STEP 5 – dCS Mosaic Network Connection

The network audio functions of your *dCS* product utilize the *dCS Mosaic* Platform for access to local streaming sources (such as a music server on your network, Roon, or AirPlay) as well as internet services (such as Deezer, Qobuz, TIDAL, and Spotify). The Vivaldi Upsampler makes use of some UPnP components in order to stream music files from a network server.

Enabling network streaming of audio using a Vivaldi Upsampler relies on the presence of standard network infrastructure in your system. A description of the network will not be discussed in this manual but at a minimum the following components are required for system setup: Router, Computer, Vivaldi Upsampler, UPnP server (typically running on a NAS device), Wireless access point (WAP), and dCS Mosaic Control running on a compatible phone or tablet.

Please note that *dCS* only supports the use of wired Ethernet for the connections between the Vivaldi Upsampler, the internet router, and the UPnP server.

dCS uses MinimServer (<https://www.minimserver.com>) as our internal engineering reference UPnP server and that is the only UPnP server software for which we offer comprehensive support. There are a wide variety of UPnP server software packages on the market and most of them are confirmed to function correctly with *dCS Mosaic Control*, but we have only fully tested *dCS Mosaic Control* with MinimServer.

For assistance with configuring your network for *dCS Mosaic Control* please contact your dealer as they have significant experience in this area and will be able to assist you directly.

Basic set-up

- Connect the system as shown below.



Figure 5 – Using a Vivaldi Upsampler and DAC with a NAS

- Download *dCS Mosaic Control* from the app store that is appropriate for your device (e.g. the App Store for iOS devices or Google Play for Android).
- Connect the Upsampler's **Network** interface to the Ethernet network.
- Select the Upsampler's **Network** input.



Open the Upsampler's Menu and select **Settings > Sync Mode > Master Mode**. (This is the basic setup without a Master Clock.)



Connect the Upsampler's **AES1+2** output (or **AES1**) to the Vivaldi DAC's **AES3+4** input (or **AES3**), as this input will accept tunnel commands from the Upsampler. (Also see page 21.)



Open the DAC's Menu and select **Settings > Sync Mode > Audio**. (This is the basic setup without a Master Clock.)

- Connect the control device (e.g. iPad) to the network.
- Launch *dCS Mosaic Control* to locate and control your Vivaldi Upsampler. (Please see the online Mosaic User Guide for full details: <https://dcs.community/mosaic-user-guide>)

Playing music with AirPlay

When the Upsampler is connected to a network, music can be streamed from an Apple device via AirPlay to the Upsampler. When AirPlay is active, the Upsampler's Network input is automatically selected.



The Vivaldi DAC's lower Output Level settings are intended to prevent accidents when driving the amplifiers directly and AirPlay is in use, as the volume set by the sending device can be very high.

Using the Vivaldi Upsampler with Spotify Connect



Spotify lets you listen to millions of songs – the artists you love, the latest hits and discoveries just for you.

If you are a Spotify user, you can control the Upsampler using your Spotify App.

1. Connect the Upsampler to the same Wi-Fi network as your phone, tablet or PC running the Spotify app.
2. Open the Spotify app and play any song.
3. Tap the song image at the bottom of the screen.
4. Tap the Connect icon. 
5. Pick the Vivaldi Upsampler from the list.

For further information on how to set up and use Spotify Connect, please visit

www.spotify.com/connect

Licenses

The Spotify software is subject to third-party licenses found here:

www.spotify.com/connect/third-party-licenses.

Using the Vivaldi Upsampler with Tidal, Qobuz, Deezer and Internet Radio

dCS Mosaic Control should be used to play music from online streaming services such as Tidal, Qobuz, Deezer, Internet Radio etc. Please see **dCS Mosaic Control** Quick Reference Guide and the **dCS Mosaic** user guide (<https://dcs.community/mosaic-user-guide>) for further information.

Using the Vivaldi Upsampler with Roon



Software version 2.01 onwards is Roon Ready. If you have a Roon account, you need to install Roon server on your NAS drive or in a networked PC. You can then use Roon remote to control playback. Roon requires a fairly powerful processor, so please check the Roon website when choosing a NAS drive.

<https://roonlabs.com/>

Playing MQA files



MQA (Master Quality Authenticated) MQA is an award-winning British technology that delivers the sound of the original master recording. The master MQA file is fully authenticated and is small enough to stream or download.

Visit www.mqa.co.uk for more information.

The MQA logo is a trademark of MQA Limited and is used under licence.

Vivaldi Upsampler v2.10 onwards can perform the 1st unfold for MQA data.



MQA files streamed bit-perfect via the **Network** (for example from Tidal Masters) or **USB2** interfaces will be unfolded to playable 24/88.2 or 24/96 MQA. The standard **MQA** icon will appear on the display, together with the original sample rate and **MQA** as the output rate (e.g. **24/352.8 > MQA**).

MQB data received on the other interfaces is recognised and passed through unchanged.

Final rendering to the original sample rate can be performed by a Vivaldi DAC loaded with software v2.10 or later.



This logo is displayed when an MQA studio file is being played.

When performing MQA playback via the network, the type of MQA stream is indicated in **dCS Mosaic Control**.



MQA decoding is not possible if the original MQA data has been changed.

In order for the MQA authentication process to work correctly the file's metadata tags need to include codes that the MQA decoder verifies. If you have edited the metadata of your MQA files, then the tags may have become corrupted. This is a very common problem as the tags and artwork provided with the files may not match a listener's preferred metadata tagging convention. This is also a common issue with files ripped from an MQA-encoded CD.

This problem is easily solved using the MQA Tag Renaming Application. When run against files that are exhibiting this issue this application will read the MQA markers in the bit stream and apply the appropriate metadata tags to the files. More information on the Tag Renaming application can be found here:

<https://www.mqa.co.uk/customer/tag435sdf43te>

STEP 6 - Using the dCS Mosaic Control as a remote control

You can use the **Mosaic Control** app to change inputs or settings. Communications between the 3 units relies on the Dual AES and RS232 connections shown below.

Fit the special 3-way RS232 cable supplied with the Upsampler Plus. Note that the 3 connectors are labelled Transport, Upsampler and DAC, each must be fitted to the correct unit.

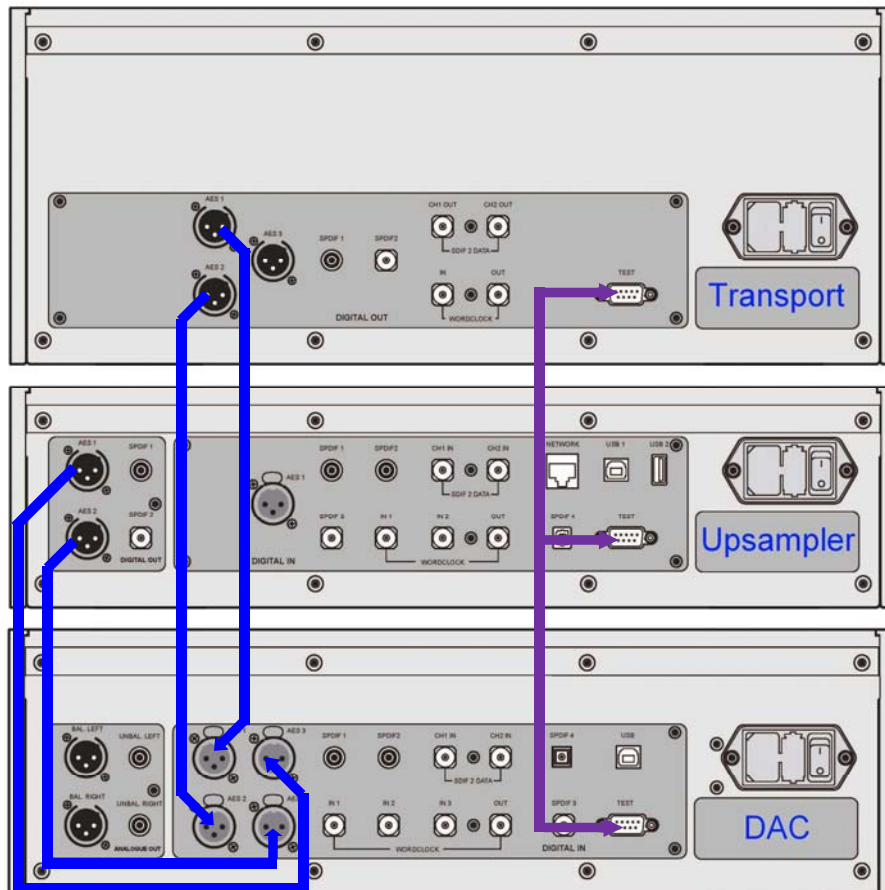

Figure 6 – **Mosaic Control** remote control connections



The **Settings > RS232 Mode** menu page on all 3 units must be set to **Binary**.

Please see the **dCS Mosaic** user guide (<https://dcs.community/mosaic-user-guide>) for more information on the supported settings.

Mosaic Control v1.0.x does not allow control of the Vivaldi Transport, there are plans to add this in a later release.

STEP 7 – Using the USB2 input

You can play compatible music files stored on a flash drive that has been formatted as FAT16, FAT32 or un-encrypted NTFS. Drives in other formats are not compatible.

- Connect the drive to the **USB2** port.
- Hold down the **Menu** button for 2 seconds to open the browser. **Waiting for USB device** may be displayed for a few seconds.
- The files and sub-folders in the root directory will be listed on the display. Use the **▶** and **◀** buttons to move the blue highlight. (The blue highlight is a cursor, it does not move when the Upsampler starts playing the next track.)



- Press the **Menu** button to either start playing a file or to move into a sub-directory.
- If you need to navigate back up the directory structure, press the **Output** button.
- Press the **Power** button briefly to close the browser.

The operation of the front panel controls returns to normal. The name of the track, the play icon and the track elapsed time will be displayed.

The Upsampler will play all the files in that directory in the sequence they appear on the flash drive and then stop.

- Use the remote control's **Previous Track**, **Next Track**, **Play/Pause** and **Stop/Eject** buttons to control playback.
- To select a different directory or re-start playback, open the browser again.



Do not try to play non-audio files, as this can cause the interface to malfunction. If you do this by accident, re-boot the Upsampler.



When the Upsampler is connected to a network, you can use a mobile device running **Mosaic Control** to control playback from the flash drive – see the **Mosaic Control** User Manual for details. The Upsampler treats the flash drive as a network drive.



The **USB2** interface is not suitable for direct connection to an Apple device. Please use AirPlay instead.



You can use the **USB2** interface with a low-power USB HDD if you wish, provided it is in a compatible format. We have used drives with capacities up to 1TB successfully, although the read time can be quite long. For larger capacities, please use a NAS drive connected via a network instead.

STEP 8 – Setting the Sync Mode for Computer Audio sources

Using the DAC in Universal Master Mode

You can improve the quality of playback from the Upsampler's USB and Network interfaces by locking the Upsampler to the DAC's clock. This does not work well in standard Master Mode as the sample rate may change between 44.1k-related rates and 48k-related rates. To solve this problem, the Vivaldi DAC with software v1.10 (or later) has a Universal Master Mode which produces a 38.4kHz word clock from which either base rate can be derived easily. Vivaldi Upsampler v1.10 (or later) can lock to this frequency.

- Add a connection from the DAC's **Word Clock Out** output to the Upsampler's **Word Clock In1** as shown below. A PC is shown connecting to **USB1**, but the data source can be connected to **USB2** or the **Network** interface instead.

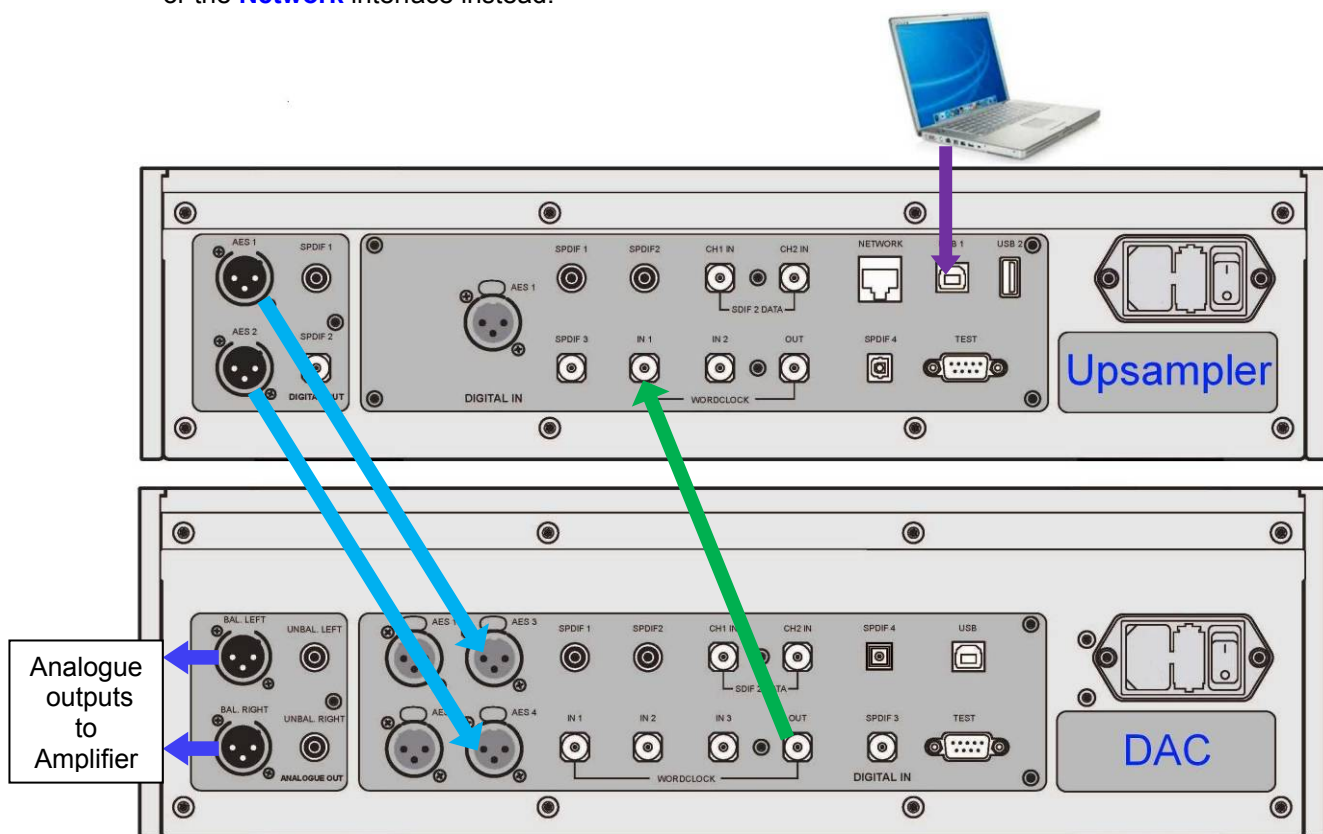

Figure 7 – Using a Vivaldi Upsampler and DAC In Universal Master Mode

- Select the Upsampler input you are using.
- Select the DAC's **AES3+4** input.



Open the DAC's Menu and select **Settings > Sync Mode > Universal Master Mode**.



Open the Upsampler's Menu and select **Settings > Sync Mode > Word Clock 1**.

The Upsampler will lock to the DAC's clock and will stay locked at any sample rate.

Using the DAC and Upsampler with a Master Clock

You can improve the sound quality further by connecting a Vivaldi Master Clock to your system as described on page 13.

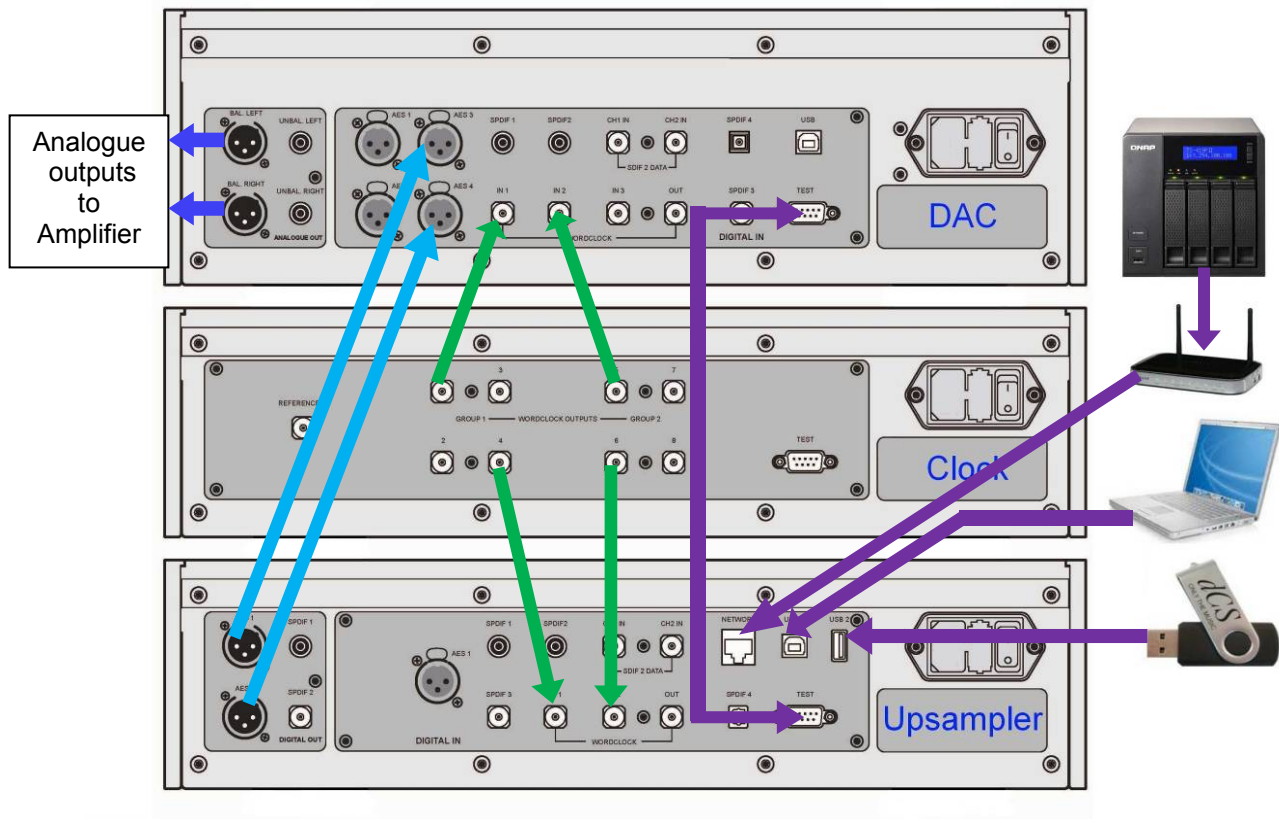

Figure 8 – Using a Vivaldi Upsampler and DAC with a Clock

- Set the Master Clock Group 1 Frequency to 44.1kHz and Group 2 Frequency to 48kHz.
- Set the Upsampler's input to the **USB1** or **Network** input as necessary.
- Set the DAC's input to **AES3+4**.



Set the **Settings > Sync mode** menu pages for the DAC and Upsampler to **Auto W1/W2**, and both units will automatically choose the clock that is synchronous with the data.



Remember to select the input before setting the **Sync Mode**.

The next step is crucial – sit back and enjoy the music.

Advanced options

Using the Web Client interface

To access the web client interface, open the [Upsampler's Information > Unit Status](#) menu page. Scroll to the third page and note the IP address of the Upsampler (192.168.0.3 in this example). Open a web browser in any device on the same network and point it to the Upsampler's IP address. The Main Page reports some information about the network. Tap Device Settings.

iPod 15:37

192.168.0.3

dCS
ONLY THE MUSIC

Main Page Device Settings Network Settings

Settings

Device Name
dCS Vivaldi Upsampler Submit

Airplay Password
Submit

Firmware Update

File
Choose File no file selected

Internet Update
Check for update

System logs
Download system logs
Download

Here you can:

- Change the **Device Name** so that you can identify different Upsamplers on the network.
- Enter the **AirPlay Password** if necessary.
- Load a Network **Firmware Update** from a file (this is rarely necessary).
- Check if an **Internet Update** is available from the update server on the internet and load it. (This is mainly for owners who are not using the Mosaic Control app.)

You can change the dynamic IP address to a fixed address on the **Network Settings** page.

Customising the input configuration

The Vivaldi Upsampler's inputs can be renamed to suit your particular system using a computer running a terminal emulator program. The Vivaldi DAC has the same feature. The procedure using a Windows PC with TeraTerm is described here, but other programs such as PuTTY or ZTerm could be used. If you have difficulty with this, please ask your Dealer for help.

- Power up the Upsampler and a Windows PC.
- If no suitable terminal program (for example Hyperterminal) is already installed, download Tera Term from <http://en.sourceforge.jp/projects/ttssh2/releases/> and install it on your PC. (If the link is broken, please search for the latest version of Tera Term online.)



Set the Upsampler's **Settings > RS232** menu page to the **Text** option.

- Use a USB-to-RS232 adapter cable to connect the Upsampler's **Test** port to one of the PC's USB ports.
- Run ttermpro.exe.
- Click the **Serial** button – Tera Term will automatically select the port connected to the Upsampler. Click **OK**.
- Click Setup > Serial Port, set the Baud rate to 4800 and click OK.

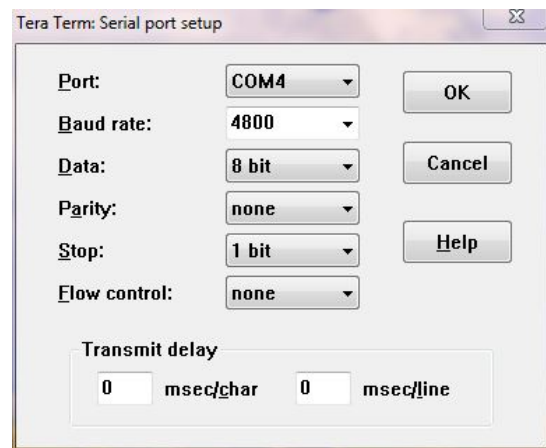

- In the terminal window, type the command: **NAME n = newname** where:
 - **n** is the number corresponding to the standard input name in the list below:

AES	0	SPDIF1	1	SPDIF2	2
SPDIF3	3	Toslink	4	SDIF-2	5
USB1	6	USB2	7	Network	9
 - **newname** is the personalised name you want to use for that input, such as CD, TV or COMPUTER. It can be up to 8 characters long, consisting of:

capital letters A-Z, numbers 0-9 or + - / = . : ? ! @ &
- Press **Enter**.

For example:

- to rename the **AES** input to CD, type: **NAME 0 = CD** and press enter.
- to rename the **Toslink** input to TV, type: **NAME 4 = TV** and press enter.



Later on, if you want to revert to the standard input names (**AES**, **SPDIF1**, etc.), select the **Configuration > Reset Input Names** menu page. Your customised input names will be permanently deleted.

FRONT PANEL



Figure 9 – Front panel

Remote Control Receiver

Aim the remote control handset towards the receiver (A) for best sensitivity.

Display – dCS Mosaic

While the Upsampler is streaming data via the **Network** or **USB2** inputs, the track name appears at the bottom of the display, with the play/pause icon and the elapsed track time at the right hand side.



The Filter, Sync Mode and Clone icons are displayed.

When using the AES / SPDIF inputs, the selected input appears at the top left corner of the display (B). To the right of this, the input word length / sample rate and output sample rate appear. The sample rates are replaced by **No Input** when a recognisable data stream is not detected.

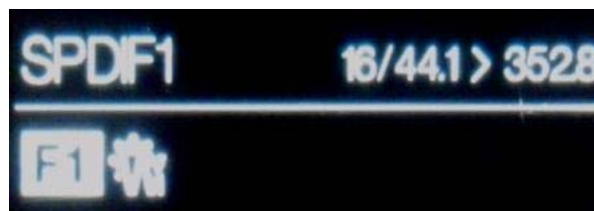

If the Upsampler is receiving a data stream in which the **NonAudio** flag has been set, the Upsampler will mute and display for example: **NA/44.1>DSD**. The Vivaldi Transport (v1.10 or later) sets the NonAudio flag when the CD tray opens and returns to Audio mode when playback starts.

Details of the menu displays are shown in the Menu section on page **34**.



To avoid unnecessary display wear, we recommend switching off or setting the unit to Sleep mode at the end of the listening session.

Control Modes

The functions of the front panel controls depend on the current operating mode of the Upsampler, as shown in the table below.

MODE					
Upsampler	Power	Menu	Filter	Input	Output
Menu	Close	Select	◀ Menu	Menu ▶	---
USB2 Browser	Close	Select	Cursor ▲	Cursor ▼	Folder ▲

Power Button

To switch on, ensure the rear panel switch is set to **I** and press the **Power** button (C) on the front panel once. Note that the unit cannot be turned on from the remote control.

To set the unit to sleep mode, press the **Power** button once. The main display will turn off, the LED (D) beside the button will light, and the digital outputs will mute, but the unit will remain close to running temperature. Press again to return to normal operation.

To switch off, hold down the **Power** button for about 3 seconds until **SWITCHING OFF** appears on the display, then release it.

When the menu is open, press the **Power** button to close the menu.

When the browser is open, pressing the **Power** button briefly closes the browser and returns the front panel controls to their normal function.

Menu Button

Press the **Menu** button (E) to open the menu, select menu pages and change settings. See the Menu section on page **34** for information on using the menu features.

When the **USB2** input is selected and media connected, hold the **Menu** button down for 2 seconds to open the browser (see page **22**). Use the **Menu** button to change to a sub-directory or select a file to play.

Filter Button

(F) The optional Filters give different trade-offs between impulse response and aliasing.

For most conversions, only **Filter 1** is available - a classic sharp filter. The amplitude is reduced by 0.1dB to match the other filters.

The best filter setting is a personal choice and may be related to the type of music.

The table below shows how many filter choices are available for each input / output combination.

		OUTPUT RATE										
		32k	44.1k	48k	88.2k	96k	176.4k	192k	352.8k	384k	DSD	DSDx2
INPUT RATE	32k	1	1	1	1	1	1	1	1	1	1	1
	44.1k		1	2	5	2	5	2	5	2	5	5
	48k			1	1	4	1	4	1	1	1	1
	88.2k				1	1	1	1	1	1	4	1
	96k					1	1	1	1	1	1	1
	176.4k						1	1	1	1	1	1
	192k							1	1	1	1	1
	352.8k								1		1	1
	384k									1		
	DSD										1	1
	DSDx2											1

For conversions with 2 filters (currently all of these have a 44.1k input rate):

Filter 1 is a classic sharp filter.

Filter 2 is a very steep, long asymmetrical filter which starts rolling off at 20kHz. This filter does not use information from before the current sample, so it does not add any extra pre-ringing. This will improve the response of the DAC's reconstruction filter by removing some high frequency components that typically cause images in half-band filter DACs.

For conversions with 4 filters:

Filter 1 has the sharpest cut-off, and so has the poorest impulse response (transient performance) but the best alias rejection (removal of out-of-band frequencies).

Filters 2, 3 and **4** have progressively gentler cut-off, with less alias rejection.

For conversions with 5 filters (currently all of these have a 44.1k input rate):

Filters 1 – 4 are the same as for conversions with 4 filters.

Filter 5 is an asymmetrical design with non-linear phase and no pre-ringing.



The **Filter** button has no effect if an input / output rate combination with only 1 filter choice is selected, or if the Upsampler is not locked to a source.

Filtering erases the MQA flags, so the filters are disabled when receiving MQA / MQB data.



“I don't have time to listen to all these filters! Which ones do you suggest?”

Filters are definitely a personal choice, but we suggest the following:

- 44.1kS/s > 48, 96, 192 or 384kS/s - Filter 2 (asymmetrical)
- 44.1kS/s > 88.2, 176.4 or 352.8kS/s or DSD – Filter 5 (asymmetrical)
- 48kS/s > 96 or 192kS/s – Filters 2 or 3
- 88.2kS/s > DSD – Filters 2 or 3

The Upsampler remembers the last filter set for each sample rate conversion (not just each input rate).

Mosaic Control location: **SETTINGS > AUDIO > dCS Processing Platform**

When the menu is open, the **Filter** button changes to the ◀ button, used to page backwards through the menu.

When the browser is open, the **Filter** button scrolls up the file list.

Input Button

Press the **Input** button (G) to change the selected input, the input name in the top left corner of the display will change.



Inputs which are not connected to an active source do not appear in the list and so cannot be selected. This is an important change from early versions. The **Network** input is always selectable.

The source sample rate is automatically detected. The full input sequence is:

..., **AES, SPDIF1, SPDIF2, SPDIF3, Toslink, SDIF-2, USB1, Network,...**

Mosaic Control location: **SETTINGS > AUDIO > Source**

When the menu is open, the **Input** button changes to the ► button, used to page forwards through the menu.

When the browser is open, the **Input** button scrolls down the file list.

Output Button

Use the **Output** button (H) to change the output sample rate, the new rate appears on the right side of the display. The output sample rate sequence is:

..., 32, 44.1, 48, 88.2, 96, 176.4, 192, 352.8, 384, DSD, DSDx2, 32,



The Vivaldi Upsampler does not feature down-sampling combinations (except from DSD or DSDx2).

Output sample rates that are lower than the input sample rate cannot be selected.

If the input rate changes so that it is higher than the output rate, the output rate will automatically change to match the input.

When the **DXD Mode** menu page is **On**, 352.8 and 384 are replaced in the sequence by **DXD**. In this mode, input data at 44.1, 88.2, 176.4 or 352.8kS/s or DSD is upsampled to 352.8, while input data at 32, 48, 96, 192 or 384kS/s is upsampled to 384kS/s.



Upsampling erases the MQA flags, so upsampling is disabled when receiving MQA / MQB data.

Mosaic Control location: **SETTINGS > AUDIO > dCS Processing Platform**

When the browser is open, the **Output** button navigates up to the previous directory (if one exists).

REAR PANEL

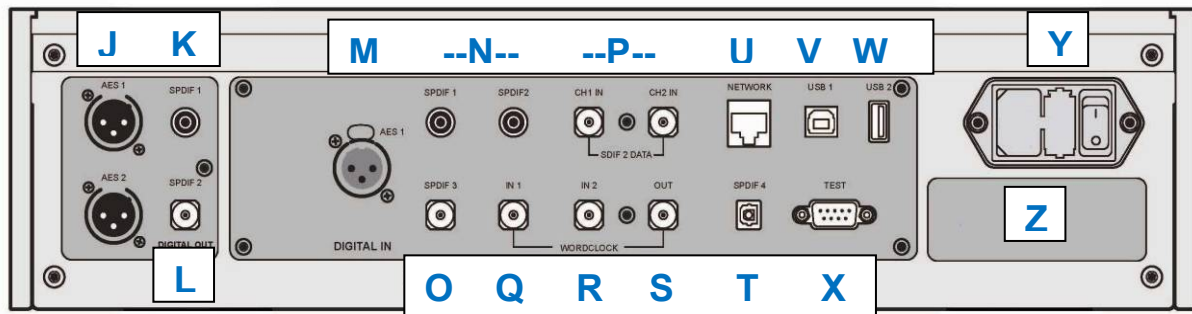

Figure 10 – Rear panel

Digital Outputs

All of the outputs consistent with the selected output mode are active at the same time.



The Vivaldi Upsampler generates 24-bit PCM data but it does not have facilities to reduce the word length to less than 24 bits. It will not give good results with older DACs (or other equipment) that cannot process 24-bit data. All dCS converters will accept 24-bit PCM data.

The **AES1** and **AES2** outputs (J) can be used individually at 32, 44.1, 48, 88.2, 96, 176.4 or 192kS/s or DSD/64 in DoP format, or as a Dual AES pair at 88.2, 96, 176.4, 192, 352.8 or 384kS/s or DSD/64 or DSD/128 in DoP format.



For Dual AES operation at 88.2, 96, 176.4 or 192kS/s or DSD/64, the **Settings > Dual AES** menu page must be set to **Dual AES On**, otherwise both outputs will carry single AES data. If the output rate is 352.8 or 384 or DSD/128, Dual AES mode is automatically selected.

2 SPDIF outputs are provided, **SPDIF1** on an RCA connector (K) and **SPDIF2** on a BNC connector (L). These outputs carry SPDIF data for output rates at 32, 44.1, 48, 88.2, 96, 176.4 or 192kS/s or DSD/64 in DoP format, even if **Dual AES** mode is **On**. They are disabled when the **Output** mode is 352.8kS/s or 384kS/s or DSDx2.

Digital Inputs

The standard PCM inputs are **AES** on a 3-way female XLR connector (M), **SPDIF1** & **SPDIF2** on RCA connectors (N), **SPDIF3** on a BNC connector (O) and **SPDIF4** on a Toslink connector (T). The electrical inputs will accept up to 24-bit data at 32, 44.1, 48, 88.2, 96, 176.4 or 192kS/s or DSD/64 in DoP format. The Toslink input accepts data at up to 96kS/s and is not tested or guaranteed at higher sample rates.

The **SDIF** interface will accept PCM data at sample rates up to 96kS/s. The interface consists of two data inputs labelled **CH1** and **CH2** (P). Operation in SDIF mode requires that a word clock from the source is connected to the **Word Clock In1** or **In2** connector (Q). Note that the interface can fail to lock correctly if the data sample rate changes but the Word Clock does not.

Word Clock Input / Output

Either of the two **Word Clock In** connectors (Q & R) will accept standard word clock from the source equipment or a master clock at 32, 44.1, 48, 88.2, 96, 176.4 or 192kHz. The clock frequency **MUST** be an exact multiple of the data rate, otherwise the system will default to **Audio** sync. Use the **Settings > Sync mode** menu page (see page 37) to lock the selected input to the selected external word clock. The source **MUST** be locked to the same clock, otherwise the system will not be locked and periodic clicks or other undesirable noises or dropouts will be heard on the outputs.

The two **Word Clock In** inputs may be used individually, but to make operation easier, the Vivaldi Upsampler's **Sync mode** menu page features a **Word Clock 1-2 Auto** mode. In this mode you can connect a 44.1, 88.2 or 176.4kHz word clock to **Word Clock In1** and a 48, 96 or 192kHz word clock to **Word Clock In2**. With a source connected to another feed from the same Clock, the Upsampler can select the correct clock frequency.

When the USB or Network interfaces are in use, the Upsampler can be locked to a 38.4kHz clock generated by a Vivaldi DAC (v1.10 or later) set to **Universal Master Mode**.

The **Word Clock Out** connector (S) carries word clock as follows:

- Single wire output – Word Clock Output frequency is the same as the sample rate.
- Dual AES output 88.2 to 192kS/s - Word Clock Output frequency is 0.5 x the sample rate.
- Dual AES output 352.8 or 384kS/s - Word Clock Output frequency is 0.25 x the sample rate.
- DSD output modes - Word Clock Output frequency is 44.1kHz.

Word Clock is used for synchronisation only, it does not carry digital data.

Network Interface

The **Network** connection on an RJ45 socket (U) allows the Upsampler to stream music data from the local network as well as from several internet services. The Upsampler can stream music files at up to 24 bits / 384kS/s or DSD/64 or DSD/128 under the control of **dCS Mosaic Control** (see page 5) running on a suitable handheld device. The Network interface runs in asynchronous mode and is galvanically isolated.



The RJ45 socket's contacts can be damaged by accidentally inserting the wrong connector (e.g. a USB type B or type A). To avoid this, we suggest leaving the dust cover fitted when not in use and fitting the RJ45 cable immediately after removal.

USB Interfaces

Both USB interfaces operate in True Asynchronous USB mode, which makes the Vivaldi Upsampler immune to clock jitter from the computer / sound server. The Upsampler uses its own internal clock or locks to the Master Clock connected to one of the **Word Clock** inputs. Feedback through the USB cable to the computer controls the data delivery rate.

The **USB1** interface on a 'B' type connector (V) will accept PCM data at up to 24 bits / 384kS/s from a Windows™ PC, Apple Mac™ PC or sound server equipped with a suitable USB 2.0 interface. The interface will also accept DSD/64 or DSD/128 data packaged in DoP format.



We have tested this interface with several common formats running on Windows™ 10 / 8.1 / 7 and Apple Mac™ OSX 11.0 with various PCM streaming programs but we cannot accept responsibility for correct operation with all source devices, operating systems or software.



The **Settings > USB Class** menu page can set the interface to **Class 1** (up to 96kS/s without a special driver) or **Class 2** (up to 384kS/s, no driver is required for OSX 10.6.3 onwards, the dCS USB Class 2 driver is required for Windows).



Correct operation in Class 2 on Windows PCs requires the 2018 version of the dCS USB Class 2 Driver. Please un-install any earlier version of the Driver from your Windows PC, download the updated Driver from www.dcsLtd.co.uk and install it.

The **USB2** interface (W) on an 'A' type connector can stream PCM music files in most popular formats at up to 24 bits / 384kS/s or up to DSD/128 from a USB Flash Drive. With a Flash Drive connected, a basic browser (see page 22) navigates to the music files and selects the file to be played. After closing the browser, the name of the file is displayed, with a Play or Pause icon and the elapsed playing time.

Mains-powered USB hard disk drives in FAT16, FAT32 or un-encrypted NTFS format may be used in the same way. The interface will not read drives in other formats.

Test interface

The **Test** interface (X) is an RS232 interface with two modes, set by the **Settings > RS232** menu page.

- **B**inary mode is used to remotely control the unit during automated production testing at dCS.
- **T**ext mode is for use with a household automation system. If you would like to use this mode, please download the list of remote control commands from www.dcsLtd.co.uk.

The interface is designed to be used with a “straight through” cable, wired pin 1 to pin 1, etc.

The pin connections are:

- Pin 2 – dCS unit transmit
- Pin 3 – dCS unit receive
- Pin 5 – ground
- Shell – cable screen & drain wire

Mains inlet

Power is connected via a standard IEC320 connector (Y), protected by a fuse and isolated by a 2-pole power switch.

Label

The label (Z) states the unit's serial number and the nominal voltage to which the unit is set. It is important to quote the serial number if you need assistance.

THE MENU

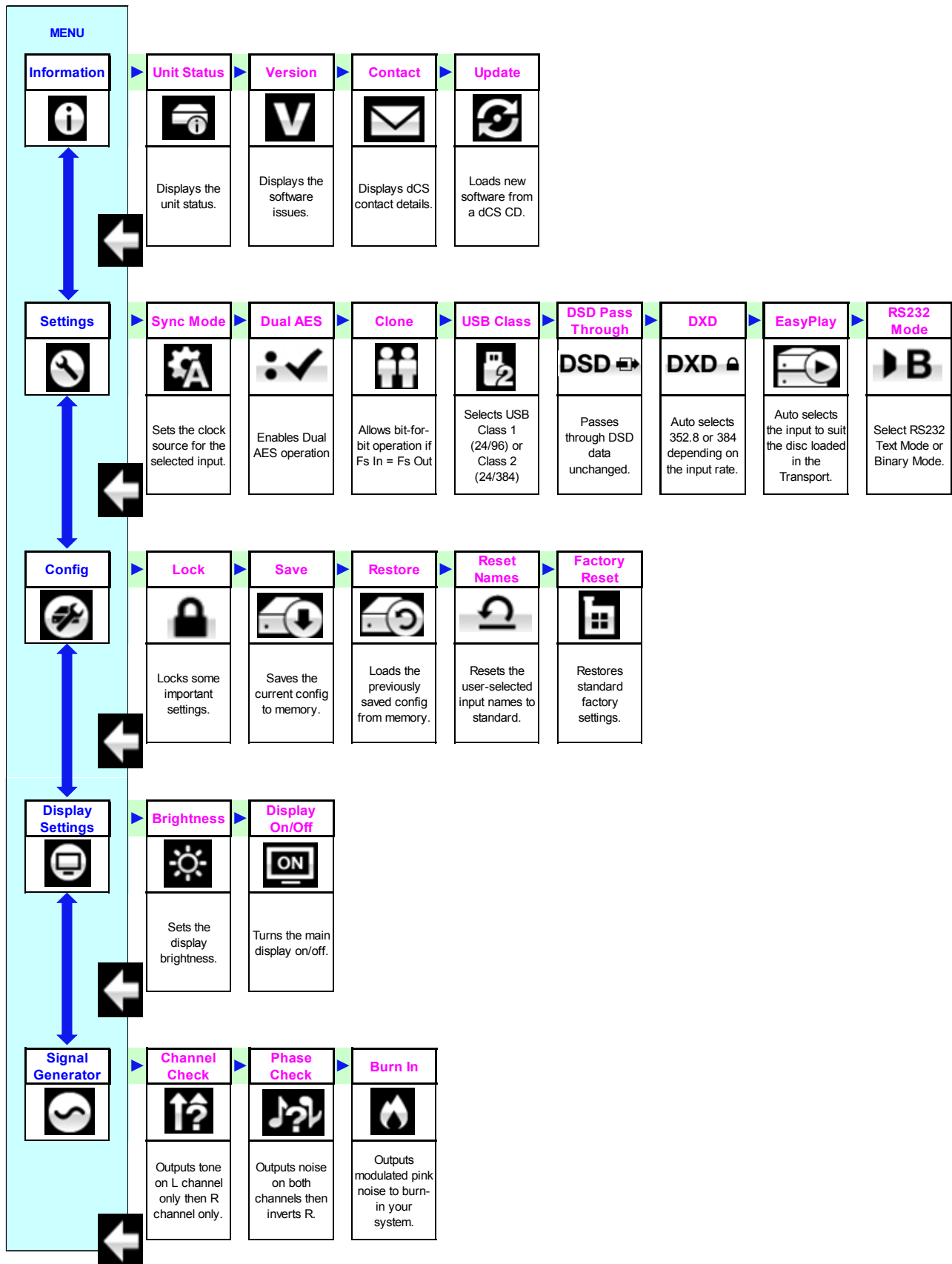

Figure 11 – The menu sequence

Using the Menu

The menu gives the user access to a range of additional features. It also allows new features and performance enhancements to be added later by software updates.

Note that **dCS Mosaic Control** can also be used to control audio and unit setting, access product information and check for firmware updates.

The menu is controlled by four buttons.

- Press the **MENU** button to open the menu or select a setting.
- Press the **▶** button to page forward through the menu.
- Press the **◀** button pages backward through the menu.
- Press the **POWER** button to close the menu or just wait 10 seconds.



Use the Menu Guide sheet to help you find the right menu page.

Each unit in the range has either four or five top-level menu pages:



The **INFORMATION** menu gives unit set-up details, software issues, serial number and contact details.



Each model has a different **SETTINGS** menu, which allows you to set some features that are not directly accessible from the front panel.



The **CONFIGURATION** menu allows you to lock important settings, save a standard setup and reset the unit.



The **DISPLAY SETTINGS** menu is used to adjust the display.



The **SIGNAL GENERATOR** menu (featured on the Transport, Upsampler and DAC only) contains test and set-up routines.

Use the **▶** button to move the blue highlight to the menu you want, then press the **MENU** button to select it. The next menu level down is displayed. Use the **▶** button to move the highlight to the menu page you want, then press the **MENU** button to display the information or change the setting.



Select the return icon to go back to the previous menu level.

INFORMATION Menu

Unit Status



The **Unit Status** page displays:

- The long version of the serial number, including the hardware configuration code.
- Internal temperature°C
- Each input and the sample rate detected on that inputS/s
- The **USB1** Audio Class setting.
- Each Word Clock input and the clock frequency detected on that inputHz.
- Network address and renderer name.

Use the ◀ ▶ buttons to scroll up or down the list. This page does not time out, press the **Menu** button to exit.

Mosaic Control location: **SETTINGS > SUPPORT > Status**



If your system is not behaving as you expect, the **Unit Status** pages can help you find set-up or connection errors.

Version



The **Version** page displays the software versions loaded in the unit. Please have this information ready if you contact your dealer for any reason:

- Control Board: 2.1x (this is the main software version)
- Front Panel: 2.1x
- Interface Board: 2.1x
- Network: xxx

This page does not time out, press the **Menu** button to exit.

Mosaic Control location: **SETTINGS > SUPPORT > Versions**

Contact



The **Contact** page displays *dCS* web-site URL and support email address. This page does not time out, press the **Menu** button to exit.

If you have any difficulty, please contact your dealer for help first.

Update



The Vivaldi Upsampler is intended to be updated over the internet using *dCS Mosaic Control* (see page 49) – this is the easiest and safest way to do it. This feature is provided for emergency use only. We do not promise to make CD Update files available for all versions.

Mosaic Control location: **SETTINGS > SUPPORT > Versions > Check for updates**

UPSAMPLER SETTINGS Menu

Sync Mode

This page sets the clocking for the digital input that is currently selected. The options are:



Audio – The Upsampler extracts the clock from the data stream connected to the selected digital input and locks to it. Use this setting for sources that do not have a suitable Word Clock input. This arrangement does NOT give the best jitter performance or the best sound quality. Sync to **Audio** is not available when the **SDIF-2**, **USB1**, **USB2**, or **Network** inputs are selected.



Master – If the **USB1**, **USB2** or **Network** inputs are selected but a Master Clock is not available, the Upsampler must be set to **Master** mode. In this mode, the Upsampler's internal clock controls the system timing.



Word Clock 1-2 Auto – This mode is designed for easy operation with a Vivaldi Clock, DAC and computer, where the data rate may keep changing. Connect the **Word Clock In1** input to a Clock output set to 44.1 or 88.2 or 176.4kHz and connect **Word Clock In2** input to a Clock output set to 48, 96 or 192kHz. The DAC's Word Clock inputs should be connected similarly. When the sample rate changes, the DAC and Upsampler will automatically select a Word Clock frequency that is synchronous with the data. The selected word clock is displayed.



Word Clock1 – The Upsampler locks to an external clock connected to the **Word Clock In1** Input.



Word Clock2 – The Upsampler locks to an external clock connected to the **Word Clock In2** Input.



If the Upsampler cannot find a word clock that is synchronous with the data, it will default to **Audio** sync (or **Master** mode for some inputs) and display the "Bad Clock" icon.



The Upsampler remembers the **Sync Mode** setting separately for each digital input. Select the required input before changing the **Sync Mode** setting.

Mosaic Control location: **SETTINGS > DEVICE**

Dual AES



The **Dual AES** menu page sets the output mode when the output sample rate is 88.2, 96, 176.4 or 192kS/s or DSD in DoP format ONLY. When set to **Dual AES On**, a stereo pair of data is split between the **AES1** and **AES2** outputs, they MUST be used together as a pair. Each wire runs at half the sample rate (44.1, 48, 88.2, 96 or 88.2kS/s respectively). The left channel data appears on the **AES1** output, the right channel data appears on the **AES2** output.



When set to **Dual AES Off**, both **AES1** and **AES2** outputs carry the same single AES data at the output sample rate. Using these together in **Dual AES Off** mode is NOT the same as a Dual AES pair.



When the output sample rate is set to 352.8 or 384kS/s or DSDx2, Single AES mode is not available, so Dual AES mode is automatically selected.

Mosaic Control location: **SETTINGS > DEVICE**

Clone Mode



With the **Clone Mode** page set to **Clone On** and the output sample rate set to be equal to the input sample rate, PCM data passes through the Upsampler unchanged (bit-perfect). So if 16-bit data is received, 16-bit data will be output. The Clone icon appears on the display when Clone Mode is on.

If the input and output sample rates change so that they no longer match, the unit will stop cloning.

This mode is useful when passing HDCD data through unchanged to a (non-dCS) HDCD converter, or for updating a dCS unit via the Upsampler.



Set to **Clone Lock**, the output rate automatically changes to match any change in the input rate, locking the unit in clone mode. The Clone Lock icon appears on the display.



Set to **Clone Off**, the unit upsamples as directed by the control setting and so the data is changed. This is the usual setting.



Clone Mode is not available if the output rate is 352.8 or 384kS/s or DSD (use **DSD Pass-Through**).

Filters are disabled in Clone Mode, as filtering prevents bit-perfect operation.

Mosaic Control location: **SETTINGS > DEVICE**

USB Class



Set to **Class 1**, the **USB1** interface will operate with Mac PCs running OSX 10.5 onwards or Windows PCs at sample rates up to 96kS/s.



Set to **Class 2**, the **USB1** interface will operate with Mac PCs running OSX 10.6 onwards at sample rates up to 384kS/s or DSD/128. Class 2 operation with Windows PCs requires that the dCS USB Class 2 driver is loaded.

Mosaic Control location: **SETTINGS > DEVICE**

After changing the USB Class, wait for 10 seconds while the correct software is loaded.



Note that the **USB1** interface will not be detected by a computer if the unit is set to **Class 2** and a suitable driver is not available.

DSD Pass-Through



With **DSD Pass Through** set to **On**, when the data received on the selected input changes to DSD, it is passed through to the output unchanged. If the data format changes to PCM, the data is upsampled to the output rate previously set.

Note that the **On** setting will prevent the output rate being set to DSDx2 from the front panel.



With **DSD Pass Through** set to **Off**, the output rate for PCM and DSD is set by the **Output** button.

Mosaic Control location: **SETTINGS > DEVICE**

DXD Mode

DXD  With **DXD Mode** set to **On**, 352.8 & 384kS/s disappear from the list of Output Rate choices, and are replaced by DXD. With DXD selected, input data that is a multiple of 44.1kS/s (including DSD) is upsampled to 24/352.8, while input data that is a multiple of 48kS/s is upsampled to 24/384.

DXD  With **DXD Mode** set to **Off**, 352.8kS/s and 384kS/s reappear in the list.

Mosaic Control location: **SETTINGS > DEVICE**

EasyPlay

Set to **On**, if the Vivaldi Transport's **AES3** output is connected to the Upsampler's **AES** input, the action of loading a CD causes the Upsampler's input to change to **AES**. If the disc is an SACD, the input does not change.



With **EasyPlay** set to **Off**, automatic input selection is disabled.

Mosaic Control location: **SETTINGS > DEVICE**

RS232 Mode

This sets the RS232 interface to either **Text** mode for use with 3rd-party control systems or...



...dCS production **Binary** mode, which is intended for factory use.

Set the **RS232 Mode** to **Binary** when using the Vivaldi 2.0 app to control the system via the 3-way RS232 cable.

CONFIGURATION Menu

Settings Lock



When set to **Locked**, this icon is displayed and the following settings cannot be changed:

- **Sync Mode** setting for all inputs
- **Dual AES** output setting
- **Output Rate** setting
- **DSD Pass-through**
- **DXD Lock**
- **USB Class**
- **RS232 Mode**
- **Save Configuration** is disabled
- **Restore Configuration** is disabled
- **Factory Reset** is disabled



Set to **Unlocked** if you need to change these settings.

Save Configuration



Once the unit is set up the way you want it, select **Save** to store the settings in memory. If you deliberately change the setup later and want to keep it, select **Save** again to store the changes.

Restore Configuration



If the unit settings are accidentally changed, select **Restore** to reload the settings you saved earlier.

Reset Input Names



If the inputs have been renamed from a computer, this page resets them to the original names: **AES**, **SPDIF1**, etc.

Factory Reset



This page resets the unit to standard settings. These are:

- **Sync Mode** to **Audio**, except
- **USB1** & **Network Sync Mode** to **Master**
- **SDIF-2 Sync Mode** to **Word Clock In1**
- **Input** to **AES**
- **Output** sample rate to 192kS/s
- **Dual AES** mode to **Dual**
- **Clone mode** to **Clone-Off**.
- **RS232** mode to **Binary**.
- **Brightness** to maximum.
- **Display** to **On**.

DISPLAY SETTINGS Menu

Brightness



Set the display **Brightness** to a comfortable level using the ◀ or ▶ buttons.

Mosaic Control location: **SETTINGS > DISPLAY**

Display On/Off



This page is usually set to **On**.



When set to **Off** and the menu closes, the display will turn off after a few seconds. The display will turn on briefly when a control setting is changed. The display will stay on if the unit is not locked or the menu is open.

Mosaic Control location: **SETTINGS > DISPLAY**

GENERATOR Menu

Channel Check



A routine to test the system for swapped channels. A tone is output on the left channel only while the display shows **Left**, then the right channel only while the display shows **Right**. If these are the wrong way around, the left and right channels are swapped somewhere in your system. This test is not affected by the **Channel Swap** menu page setting.

Mosaic Control location: **SETTINGS > SYSTEM TEST**

Phase Check



A routine to test the system for phase reversals. Noise is output in phase on both channels while the display shows **In Phase**. Press the **Menu** button, the noise on the right channel is inverted while the display shows **Out of Phase**. The first burst should produce a central image, the second burst should not. If these are the wrong way around, one channel in your system is phase inverted. Press the **Power** button to stop the test and return to the menu.

Mosaic Control location: **SETTINGS > SYSTEM TEST**

Burn In



A procedure to condition your system. The unit displays **Burn In Caution! Loud**, then outputs modulated pink noise that ramps up and down slowly in level. Press the **Menu** or ◀ or ▶ buttons to stop the procedure.



Please ensure that the volume level is reasonable, as careless use of the **Burn In** feature can damage your amplifiers and loudspeakers. dCS will not be liable for such damage.

CONFIGURATION WITH MOSAIC CONTROL

Many of the settings that are contained in the device's **Menu** (detailed above) are also accessible from within the *dCS Mosaic Control* application.



Tapping the **SETTINGS** button will open the settings drawer from the left side of the screen.

The following functions are available through the settings interface.

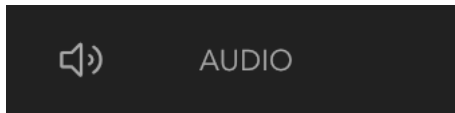

The **AUDIO** button will display the signal path of your unit and allow you to change settings related to input, output, and signal processing.

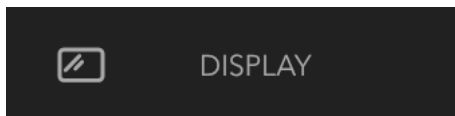

The **DISPLAY** button will allow you to modify settings related to the device's front panel display.

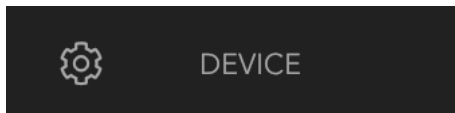

The **DEVICE** button will allow you to change device-related settings and less-frequently-used audio-related settings.

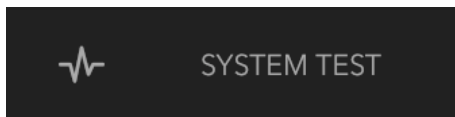

The **SYSTEM TEST** button will allow you to run a number of tests to ensure your device is connected properly.

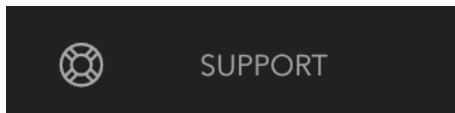

The **SUPPORT** button will display information about the current status of the device, its installed software, as well as allow you to check for software updates.

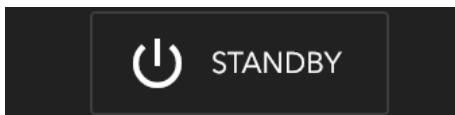

Holding the **STANDBY** button for two seconds will place your unit into sleep mode. This is the equivalent of a press of the front panel **Power** button.

Directions to the location of a specific setting within Mosaic Control are provided along with its description in the MENU section of this manual. For instance, the **Filter** setting is at the following location:

SETTINGS > AUDIO > dCS Processing Platform

That means that to access the Filter setting you would execute the following steps in *dCS Mosaic Control*:

- Tap the **SETTINGS** button to open the Settings Drawer
- Tap **AUDIO** to open the Signal Path
- Tap the **dCS Processing Platform** area to open the filter selector

SPECIFICATION

Digital inputs	<p>UPnP Network interface on an RJ45 connector streams music files from a NAS or local computer using MinimServer over an Ethernet network. Supported file formats are:</p> <ul style="list-style-type: none"> • FLAC, AIFF, WAV & M4a – up to 24 bit PCM at 44.1, 48, 88.2, 96, 176.4, 192, 352.8 or 384kS/s. • ALAC – up to 24-bit PCM at 44.1, 48, 88.2, 96, 176.4 & 192kS/s. • AAC, MP3 - up to 24-bit PCM at 44.1 or 48kS/s. • DFF, DSF & DoP – DSD/64 & DSD/128 <p>Supports TIDAL, Qobuz, Deezer, Internet Radio and Podcasts via AirAble.</p> <p>The interface will accept audio data streamed from an iPad, iPod or iPhone (which are currently limited to 44.1 or 48kS/s) via Apple AirPlay, also Android devices running UPnP software.</p> <p>The Network interface operates in asynchronous mode.</p>
	<p>USB1 interface on a B-type connector, will accept up to 24 bit PCM at:</p> <ul style="list-style-type: none"> • 44.1, 48, 88.2 or 96kS/s when set to USB Class 1 (no driver required). • 44.1, 48, 88.2, 96, 176.4, 192, 352.8 or 384kS/s when set to USB Class 2 (no special driver is required for OSX 10.6.3 onwards, load the latest <i>dCS</i> USB Class 2 driver for Windows). • In USB Class 2 mode, passes through DSD/64 or DSD/128 in DoP format. <p>The USB1 interface operates in asynchronous USB mode.</p>
	<p>USB2 interface on A-type connector, streams audio files from a USB flash drive up to 24 bit PCM at 44.1, 48, 88.2, 96, 176.4, 192, 352.8 or 384kS/s plus DSD/64 or DSD/128. Compatible file formats are listed in the UPnP Network interface section above.</p> <p>The USB2 interface operates in asynchronous USB mode.</p>
	<p>AES3 on a 3-pin female XLR connector, will accept up to 24 bit PCM at 32, 44.1, 48, 88.2, 96, 176.4 or 192kS/s or DSD/64 in DoP format.</p>
	<p>3x SPDIF on 2x RCA Phono and 1x BNC connectors. Each will accept up to 24 bit PCM at 32, 44.1, 48, 88.2, 96, 176.4 or 192kS/s or DSD/64 in DoP format.</p>
	<p>Optical SPDIF on TosLink connector, will accept up to 24 bit PCM at 32, 44.1, 48, 88.2 or 96kS/s.</p>
	<p>1x SDIF-2 interface on 2x BNC connectors, will accept up to 24 bit PCM at 32, 44.1, 48, 88.2 or 96kS/s or SDIF-2 DSD/64 (auto-selected). This interface requires a compatible word clock connected to one of the Word Clock Inputs, locked to the data rate.</p>
Digital outputs	<p>2x AES3 on 3-pin female XLR connectors. Each outputs 24 bit PCM at 32, 44.1, 48, 88.2, 96, 176.4 or 192kS/s or DSD/64 in DoP format,</p> <p style="text-align: center;">-OR-</p> <p>used as a Dual AES pair at 88.2, 96, 176.4, 192, 352.8 or 384kS/s or DSD/64 or DSD/128 in DoP format.</p>
	<p>2x SPDIF on 1x RCA Phono and 1x BNC connectors. Each outputs 24 bit PCM at 32, 44.1, 48, 88.2, 96, 176.4 or 192kS/s or DSD/64 in DoP format.</p>

MQA	Performs the first unfold of MQA data received on the Network or USB2 interfaces and outputs the data in MQA format. MQB data received on the other inputs will be recognised and passed through.
Clocking	2x Word Clock Inputs on 2x BNC connector, accepts standard word clock at 32, 44.1, 48, 88.2, 96, 176.4 or 192kHz. The data rate can be the same as the clock rate or an exact multiple (such as 0.25x, 0.5x, 1x, 2x, 4x, 8x) of the clock rate. Sensitive to TTL levels. The Word Clock Inputs will also accept 38.4kHz word clock from a Vivaldi DAC set to Universal Master Mode.
	Word Clock Output on 1x BNC connector, outputs standard word clock at a frequency equal to the (single wire) output data rate, or 44.1kHz when set to output DSD.
Upsampling rates	Data from any input may be converted to 24 bit PCM at 32, 44.1, 48, 88.2, 96, 176.4, 192, 352.8 or 384kS/s or DSD (1 bit data at 2.822MS/s) or DSDx2 (1 bit data at 5.644MS/s). The output sample rate must be equal to or greater than the input sample rate. The supported combinations are listed in the table on page 29 .
Spurious responses	Better than -100dB0, 20Hz-20kHz
Optional filters	A choice of filters is available for 12 popular conversions, see page 29 for details.
Size and weight	444mm (17.5") long x 435mm (17.2") deep x 125mm (5.0") high, excluding cable connectors. Allow space for air flow around the unit. 14.2kg (31.3lbs).
Power requirements	Internally set to either 100, 115/120, 220 or 230/240V AC, 50/60Hz. Power consumption: 15W typical, 50W maximum. Consumes less than 0.5W when powered down from the front panel.

These specifications are subject to change without notice.

MAINTENANCE AND SUPPORT

Service and Maintenance

dCS audio products are designed not to need regular maintenance, and contain no user serviceable parts apart from the mains fuse. If your unit is damaged in any way, please contact your dealer.

Replacing a Blown Mains Fuse

There is a mains fuse below the power inlet, accessible from the outside of the unit. If the fuse blows, it may be changed by the user. The current consumption of the unit is very low, so it only blows if power surges occur, or there is a fault in the unit. Usually power surges cause no other damage, but if the fuse blows repeatedly on replacement, some other damage will have been done and the unit must be returned to dCS for repair.

Fuse type: 20 x 5mm T 1 amp L fuse



If the fuse should fail, it is essential that it is replaced with one of the same type and rating. Failure to do so could result in damage to the unit, risk of fire or electric shock and will invalidate the warranty. Fuse failure is rare!

Referring to the diagram below, remove the power cable, use your fingernails to catch the two tabs of the fuse holder (A), push them together to release the clips and pull the fuse holder out. Pull out the blown fuse from the lower position (B) and discard it. Either move the Spare Fuse (C) to the lower position or fit one of the fuses from the manual pack. Orient the fuse holder as shown (D) and push the holder back into the power inlet so that it clicks home.

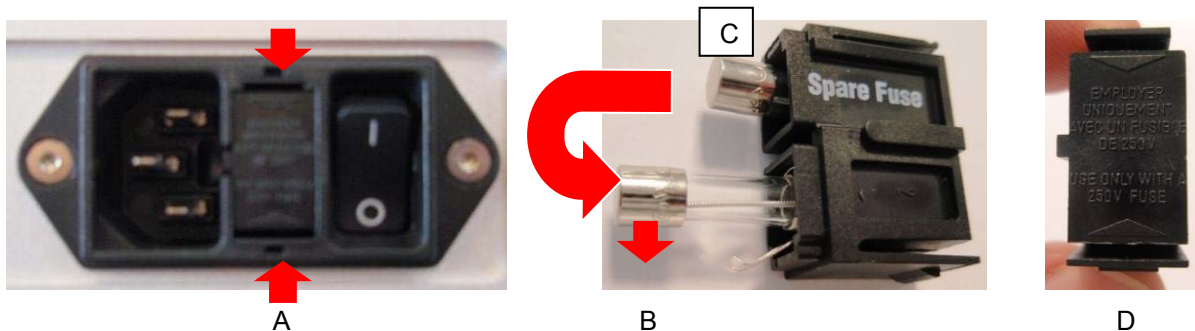

Cleaning the case

The front and back panels of your dCS equipment are machined from very high grade aluminium. Great care has been taken to create the finish of the aluminium throughout the engineering process from the raw solid material to the finished piece.

To remove loose dust or finger marks from the case, we recommend that you use a clean, dry, lint-free cloth.

To restore the finish, we recommend applying small quantities of a lanolin based cleaner, using a clean, dry, lint-free cloth and then wiping off. Do not allow lanolin to collect around the buttons.

Small amounts of glass cleaner containing ammonia may be used to clean other surfaces, but avoid spraying onto the connector contacts.

Limited Warranty

General

dCS warrants this product against defects in materials and workmanship for a period of 3 years from the date the unit was originally shipped from dCS. If the product is purchased and registered with dCS within 6 months of the date the unit was originally shipped from dCS, we will start the warranty on the purchase date. For units registered later than 6 months from the ship date, we will start the warranty from the ship date unless the registration is supported by the original sales invoice. During the warranty period, dCS will repair or, at our absolute discretion, replace a faulty product. Warranty repairs must only be carried out by dCS or our authorised service agents. Please contact your dealer if your unit requires service.

To register this product, either register online at www.dcsLtd.co.uk or complete the **Product Registration** form within 30 days of the sale and return it to dCS. On receipt of the registration, dCS will add your contact details to our customer database. dCS will use this information for warranty purposes only, we will not contact you directly for reasons relating to sales and marketing.

This warranty applies to the original owner, it is not transferable.

Warranty Exclusions

The Warranty does not cover wear and tear.

The Warranty on this product will be void if:

- the product is misused in any way.
- any unauthorised modifications or repairs are carried out.
- the product is not used in accordance with the Operating Conditions stated in this manual.
- the product is serviced or repaired other than by dCS or our authorised service agents.
- the product is operated without a mains earth (or ground) connection.
- the unit is returned inadequately packed.

dCS reserve the right to apply a service charge if a product returned for warranty repair is found to be operating correctly, or if a product is returned without a returns number being issued.

This warranty covers parts and labour only, it does not cover shipping charges or tax/duty.

Our dealers or distributors are NOT authorised to extend the terms of this warranty, dCS cannot accept responsibility for any attempt to do so.

Products re-sold by dCS on a "used" basis may be subject to reduced warranty terms.

Obtaining Service

Should you encounter a problem, contact your authorised dCS dealer for advice, quoting the model, the full serial number, software version number, and giving a detailed description of the fault. Your dealer will advise you fully on actions that need to be taken. When returning a unit, the original packaging should be used to avoid transit damage. Replacement packaging sets may be purchased from dCS.

During the Warranty period, there will normally be no charge for parts or labour.

Operating Conditions

- The supply voltage must remain within +/-10% of the A.C. voltage specified on the back panel.
- The supply frequency must be in the range 49Hz to 62Hz.
- Ambient temperature range: 0°C (32°F) to 45°C (113°F), non-condensing.
- Do not install the unit near heat sources such as radiators, air ducts, power amplifiers or direct strong sunlight.
- If in doubt, the easy test is – the unit is happy to work anywhere a human is.

If you need more help

In the first instance, you should contact your dealer. If they cannot resolve the issue, contact your national distributor.



dCS, our dealers and distributors cannot accept responsibility for I.T. support issues. In such cases, please ask the computer or software vendor for advice.

Manufactured by:

Data Conversion Systems Ltd.
Unit 1, Buckingway Business Park,
Anderson Road,
Swavesey,
Cambridgeshire. CB24 4AE
UK

www.dcsLtd.co.uk

This user manual may be downloaded free of charge from our web-site.

A bound copy of this manual may be ordered from *dCS*.

Software History

dCS products make extensive use of software configurable chips – FPGAs and DSPs. This gives us the ability to update our products to add extra features, update digital interface standards or make performance improvements by loading new software. Occasionally, a hardware update may be necessary also to increase the “capacity” of the electronics, add extra connectors or extra front panel controls.

Please note that not all software updates produce an audible improvement. We recommend that you keep your software up to date. Check the dCS web-site occasionally for news of the latest software updates.

This manual is for Vivaldi Upsampler Plus software version 2.1x.

Issue 1.00	The first issue, hardware type VUP .
Issue 1.01	Reliability improvement.
Issue 1.02 / Network v56	Integrates the Upsampler with the dCS Apps for iPad & iPhone/iPod, adds extra RS232 commands, corrects a Network Update bug.
Issue 1.10 / Network v57	<p>Configuration menu added, with Settings Lock, Save & Restore Configuration, DXD Lock and DSD Pass features added to the Settings menu.</p> <p>Inputs that are not connected and active cannot be selected.</p> <p>The USB1 input accepts 24-bit data at 352.8 and 384kS/s.</p> <p>New conversions added: 352.8 > DSD, DSD > 176.4 / 192 / 352.8 / 384kS/s.</p> <p>Support for EasyPlay, Vivaldi DAC's Universal Master Mode, Non-Audio muting added.</p> <p>RS232 commands updated, USB2 browser improved, iPod playback improved.</p> <p>USB2, iPod & Network inputs can be renamed.</p> <p>Various minor bugs fixed.</p>
Issue 1.20 / Network v63	<p>Network and USB2 inputs can stream DFF/DSF DSD/64 files.</p> <p>More RS232 Text mode commands added.</p>

Software version 2.00 onwards is compatible with hardware type **VPP**, it will not run on VUP units. VPP features a new network streaming board, with galvanically isolated Network and USB1 interfaces.

Issue 2.01 / Network 307	<p>Network, USB and Dual AES interfaces support DSD/128 (DSDx2).</p> <p>Extra conversions added: 32 - DSDx2 > DSDx2, 176.4 – 352.8 > DSDx2. There are 6 filters for 44.1 > DSDx2, 1 filter for the other new conversions.</p> <p>Improved RS232 integration.</p> <p>iPod input deleted, mobile devices play via AirPlay instead.</p> <p>USB2 input is now accessed as part of the Network interface, not as a separate input.</p> <p>EasyPlay feature added to the Settings menu.</p> <p>Support for Vivaldi 2.0 control app added, using a 3-way RS232 link.</p> <p>Room Ready.</p> <p>Filter 6 was deleted (it was a duplicate of Filter 5).</p>
Issue 2.02 / Network 350	Reliability and compatibility improvements.
Issue 2.10 / Network 370	MQA first unfold added for the Network and USB2 interfaces. MQB data received on other interfaces is recognised and passed through unchanged.
Issue 2.10 / Network 501	Network firmware updated for compatibility with dCS Mosaic Control v1.0.x

Software update

The Vivaldi Upsampler v2.10 onwards can be updated from the internet over the network using *dCS Mosaic Control* app. Tap **SETTINGS > SUPPORT > Versions > Check for Updates**. If an update is available, please follow the prompts and then wait until the process is complete.

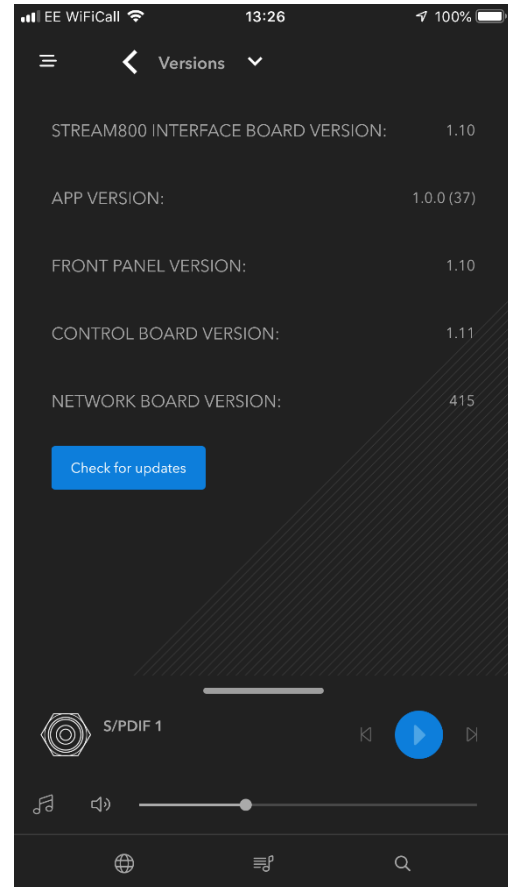
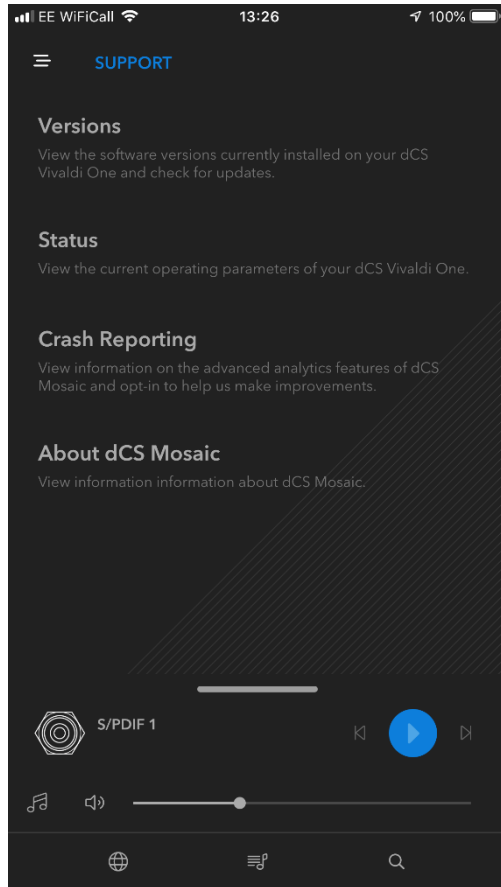

An update can take 45 minutes, please be patient.
Please do not switch the unit off until "Please switch off" is displayed.

A		I		O	
AES input.....	10, 31	information menu.....	36	operating conditions	46
AES output	12, 31	input		output	
AirPlay	19	AES.....	10, 31	AES.....	12, 31
B		disabled.....	30	Dual AES	11, 31
bit perfect.....	38	network	18, 32	sample rates	31
browser	22	rename.....	26	SPDIF	12, 31
close.....	28	sample rates	31	word clock.....	32
navigate up	30	SDIF-2.....	10, 31	output button	30
scroll down	30	SPDIF	10, 31	P	
scroll up.....	29	Toslink.....	10, 31	PC setup.....	16
start.....	28	USB1.....	15, 33	phase check	41
burn in.....	41	USB2.....	22, 33	positioning	6
C		word clock.....	32	power button.....	28
cables	9	input button.....	30	power off.....	28
channel check.....	41	input selection		power up.....	9, 28
cleaning	45	Mosaic Control.....	30	R	
clock frequencies.....	32	L		rear panel	31
clone mode	38	lock	40	remote control	27, 33
compatibility		M		rename device.....	25
operating systems..	15, 33	mains inlet	33	rename input	26
UPnP control point.....	8	master clock	13, 24	reset.....	26, 40
configuration		menu.....	34	restore configuration.....	40
menu	40	close.....	28	Roon Ready	19
reset	40	configuration	40	RS232.....	33, 39
restore	40	display.....	41	S	
save.....	40	generator.....	41	safety	6, 7
contact	36	information	36	save configuration	40
control modes	28	settings.....	37	SDIF-2 input	10, 31
D		using	28	serial number.....	33, 36
display.....	27	menu back button.....	29	service	45
brightness	41	menu button.....	28	settings lock.....	40
Mosaic.....	27	menu forward button	30	settings menu	37
NA	27	menu, using.....	35	setup guide.....	9
off.....	41	Mosaic	5, 18, 32, 42, 49	sleep.....	28
display menu	41	Deezer	19	software	36, 48
DSD pass through	38	device configuration.....	42	SPDIF input	10, 31
Dual AES output..	11, 31, 37	display.....	27	SPDIF output.....	12, 31
DXD mode	30, 39	input selection.....	30	specification.....	43
E		internet radio	19	Spotify.....	19
EasyPlay.....	39	mosaic control.....	18, 21	status	36
enhanced clocking.....	13	podcasts.....	19	sync mode.....	13, 18, 23, 24, 37
F		Qobuz	19	T	
feet.....	6	TIDAL	19	Toslink input	10, 31
file formats	43	updates	49	U	
filter 1 only?	29	UPnP.....	18	update.....	25, 36, 48, 49
filter button.....	29	user guide	18	USB	
filter choices.....	29	using with Roon	19	class.....	15, 33, 38
flash drive	22	using with Roon	19	Windows driver	15
front panel.....	27	MQA	20, 27, 29	USB1 input	15, 33
fuse, replacing	45	file tags.....	20	USB2 input	22, 33
G		N		V	
generator menu	41	NAS drive	18	version	36
		network		voltage.....	33
		input	18, 32		
		setup	18		

W		web client..... 25
wake	28	word clock..... 13, 23, 24, 37
warranty	46	word clock input..... 32