

***dCS* Vivaldi Clock**
Digital Audio Master Clock

User Manual
Software Release 1.2x
May 2017

© Data Conversion Systems Ltd. 2012 - 2017

Price UK £10.00

All rights reserved. No part of this publication may be reproduced, stored in or introduced into a retrieval system, or transmitted in any form, or by any means (electronic, mechanical, photocopying, recording or otherwise) without the prior written permission of *dCS*¹. Any person who does any unauthorised act in relation to this publication may be liable to criminal prosecution and civil claims for damages.

Information contained in this manual is subject to change without notice, and whilst it is checked for accuracy, no liabilities can be accepted for errors.

¹ *dCS* is Data Conversion Systems Ltd. Company registered in England No. 2072115.

Contents

Using the dCS Vivaldi Clock for the first time	4
What's in the box?	4
Positioning the unit	4
Important Safety Instructions	5
Safety Notice	6
Step-by-Step Guide	7
Preliminaries	7
The GOLDEN RULES for using a Master Clock	7
Connecting the system for CD/SACD playback	8
A full Vivaldi system	9
Using an External Reference	10
Using sources that cannot lock to Word Clock	10
Front Panel	11
Remote Control Receiver	11
Display	11
Power Button	12
Menu Button	12
Freq1 Button	12
Freq2 Button	12
Rear Panel	13
Reference Input	13
Word Clock Outputs	13
Test interface	13
Mains inlet	14
Label	14
The Menu	15
Using the Menu	16
INFORMATION Menu	17
Unit Status	17
Version	17
Contact	17
Update	17
CLOCK SETTINGS Menu	18
Reference In	18
Dither	18
RS232 Mode	18
CONFIGURATION Menu	19
Settings Lock	19
Save Configuration	19
Restore Configuration	19
Factory Reset	19
DISPLAY SETTINGS Menu	19
Brightness	19
Display On/Off	19
Specification	20
Maintenance and Support.....	21
Service and Maintenance	21
Replacing a Blown Mains Fuse	21
Cleaning the case	21
Limited Warranty	22
If you need more help	23
Software History	23
Index	24

USING THE *dCS* VIVALDI CLOCK FOR THE FIRST TIME

Congratulations on purchasing your *dCS* Vivaldi Clock.

Before using your unit, please read this section and the Step by Step Guide. This will enable you to set the unit up quickly and safely with your hi-fi system.

From time to time, *dCS* will release updated software on CD that you can install yourself using the **Update** feature. Please check our web-site occasionally to see if new Vivaldi software is available, or consult your dealer.

What's in the box?

Check that the box contains the following items:

- *dCS* Vivaldi Clock
- Manual and Menu / Setup Guide
- Power cable
- 2x BNC cables
- Spare fuses

Notify your dealer as soon as possible if anything is missing or damaged. We suggest that you retain the original packaging for possible future use. If this is not possible, replacement packaging can be ordered from *dCS* or our distributors. Details can be found on our web site at www.dcsltd.co.uk.

A *dCS* remote control is supplied with the Vivaldi DAC.

Positioning the unit

For best sound quality, the units in the Vivaldi range are designed to be mounted on separate shelves of a rack, although they may be stacked directly on top of each other if this is absolutely necessary. Place each unit on a firm, vibration free base, allowing convenient connection to the other parts of your system. To prevent overheating, we recommend that you leave some free space around the unit to allow for ventilation.

The unit is supplied with 4 feet fitted. If you prefer a 3-feet layout, unscrew the two back feet, remove the two black cores using a 2.5mm A/F Allen key, fit one of the cores in the middle position and replace the foot. Take care not to cross-thread the foot!

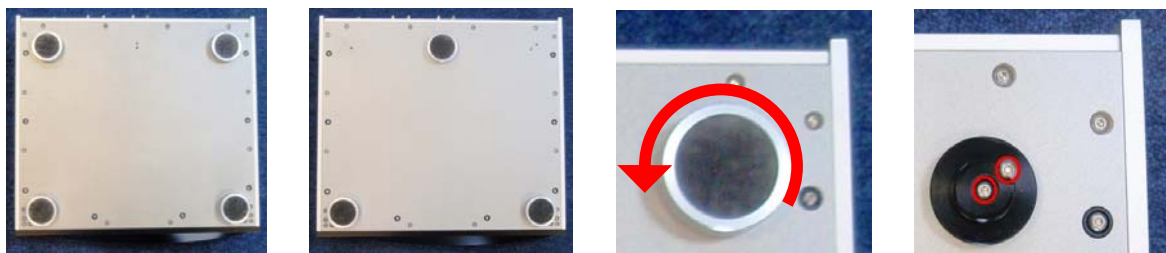

With all feet screwed fully home, the unit will sit level on a flat surface. If you need to do any levelling, you can unscrew any of the feet up to 3 complete turns, to give up to 3mm (1/8") of height adjustment.

Important Safety Instructions

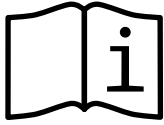

The following statements are required to comply with U.S. safety standard UL60065.

- Read these instructions.
- Keep these instructions.
- Heed all warnings.
- Follow all instructions.
- Do not use this apparatus near water.
- Clean only with dry cloth.
- Install in accordance with the manufacturer's instructions.
- Do not install near any heat sources such as radiators, heat registers, stoves, or other apparatus (including amplifiers) that produce heat.
- Do not defeat the safety purpose of the grounding-type plug. A grounding type plug has two blades and a third grounding prong. The third prong is provided for your safety. If the provided plug does not fit into your outlet, consult an electrician for replacement of the obsolete outlet.
- Protect the power cord from being walked on or pinched particularly at plugs, convenience receptacles, and the point where they exit from the apparatus.
- Only use attachments/accessories specified by the manufacturer.
- Unplug this apparatus during lightning storms or when unused for long periods of time.
- Refer all servicing to qualified service personnel. Servicing is required when the apparatus has been damaged in any way, such as power-supply cord or plug is damaged, liquid has been spilled or objects have fallen into the apparatus, the apparatus has been exposed to rain or moisture, does not operate normally, or has been dropped.

Safety Notice



In the event of the unit developing a fault, please contact your dealer in the first instance.

If you decide to remove safety covers for any reason, disconnect the power cable first. Note that removing covers voids the warranty.

To maintain protection from electric shock, the unit **MUST** be connected to mains earth (ground) via the power cable. Also, unearthed systems do not give the best sonic performance.

Protect the product from dripping or splashing liquids. Liquid-filled objects such as vases must not be placed on the product.



This product is not suitable for operation at altitudes above 2000m.



This product is lead-free and complies with the RoHS directive.

Before connecting the power cable to the unit for the first time, please check that it has been set to the correct operating voltage for your mains supply. The unit's voltage setting is shown on the serial number label. If this does not match your local supply voltage, **DO NOT** attempt to use the unit. Contact your dealer to have the unit reset. Using the unit with the wrong mains setting for your local supply may result in serious damage to the unit and will invalidate the warranty. Do not attempt to reset the voltage yourself.

We do not recommend the use of mains regenerators. However, if you do wish to use a mains regenerator with variable voltage and frequency, we recommend that you set the voltage to match your local voltage and the frequency to either 50Hz or 60Hz **ONLY**.



Damage caused to your Vivaldi Clock by misuse of a mains regenerator or by a malfunctioning mains regenerator is not covered by the warranty.



Disposal at end-of-life - the symbol indicates that this product should not be treated as normal household waste. It should be recycled, so please take it to an approved collection facility.

STEP-BY-STEP GUIDE

This section guides you through setting up the unit for basic operation.

Preliminaries

The Menu Guide sheet details the menu structure.

For all of the **Word Clock Outputs** and the **Reference Input**, use 75Ω coax cables fitted with BNC plugs.

Connect the power cable supplied to the power inlet on the Clock rear panel, plug the other end into a convenient power outlet.



Please do not use an excessively heavy or inflexible power cable as this may damage the power inlet connector.



The cables supplied with the unit are “commercial grade”, because most owners will have their own “audiophile grade” cables or will prefer to make their own cable choices.

Set the rocker switch near the mains inlet to the **I** position. Press the **Power** button - the unit will display **Vivaldi Clock**. Wait about 30 seconds while the Clock configures itself.

If the unit is likely to be set in an unfamiliar state, you can run the **Factory Reset** routine by pressing the buttons in this sequence: **Menu, ▶, ▶, Menu, ◀, ◀, Menu**.

Wait a few seconds while the unit resets itself.

The GOLDEN RULES for using a Master Clock

1. The source equipment **MUST** be locked to the Master Clock.

If it is not, you will either have locking difficulties or hear occasional clicks or drop-outs and the advantages of using the Clock will be lost.

Many non-dCS CD transports, satellite receivers, DAB radios and other equipment do not have a Word Clock Input and so CANNOT be locked to a Master Clock.



When a computer or sound server is driving a dCS unit (USB DAC, Upsampler or U-Clock) via a true asynchronous USB or Network interface, the dCS unit controls the clocking and behaves as the source equipment. dCS USB DACs and Upsamplers can either use their internal clock or lock to a Master Clock.

2. The clock frequency **MUST** match the sample rate(s) used in the system.

If it does not, the system cannot lock and the DAC may remain muted. Please check the manuals for the equipment used in your system.

44.1kHz Word Clock is compatible with DSD-based systems, CD systems without an upsampler running at 44.1kHz or CD systems upsampling to 88.2kS/s, 176.4kS/s or 352.8kS/s, or a computer streaming data at 44.1, 88.2, 176.4 or 352.8kS/s.

48kHz Word Clock is compatible with a DVD player or DAT recorder fitted with a Word Clock Input running at 48kS/s, or upsampling to 96kS/s or 192kS/s, or a computer streaming data at 32, 48, 96, 192 or 384kS/s.

To make best use of a Master Clock, all the digital audio units in the chain should be locked to it.

In a Vivaldi system, you can use multiples of the base clock frequency. If you wish, you can try 88.2 or 176.4kHz instead of 44.1kHz and 96 or 192kHz in place of 48kHz.

Connecting the system for CD/SACD playback

Many owners will use the Vivaldi Clock to clock a Vivaldi stack at 44.1kHz.

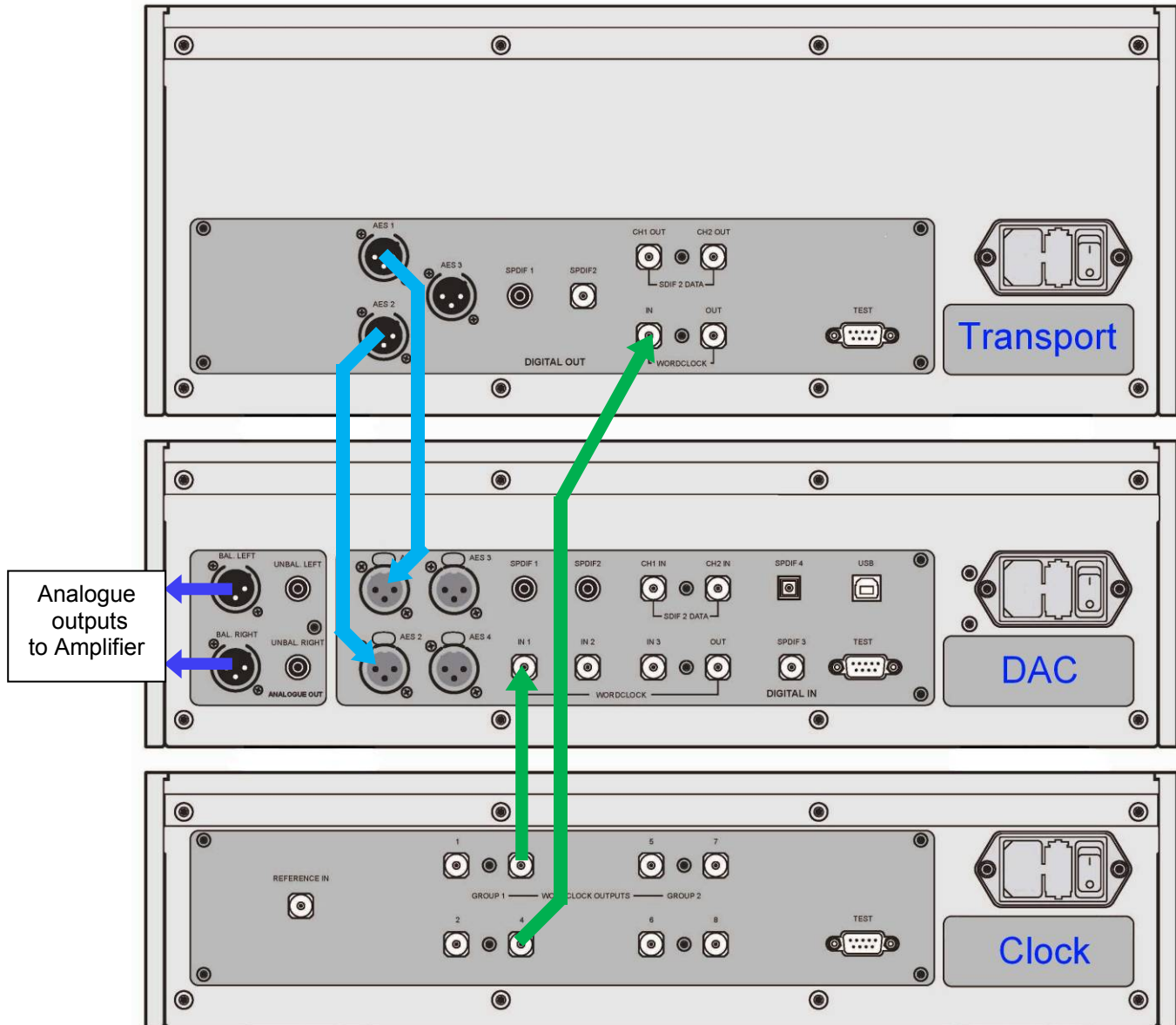

Figure 1 – Using the Vivaldi Transport, DAC and Clock together

- Connect the system as shown above.
- Use the Clock's **Freq1** button to set the **Group 1 Outputs** to **44.1kHz**, to suit the CD Transport.



To sync the DAC to **Word Clock 1**, open the menu, navigate to the **Settings > Sync Mode** menu page. The button sequence is: **Menu**, **▶**, **Menu**, and then use the **Menu** button to select the **Word Clock 1** icon.

The system will re-lock and un-mute.

- Set the Clock's **Settings > Group1 Dither** menu page **On** or **Off** as you prefer.

A full Vivaldi system

The Vivaldi's clocking system has been designed to be very comprehensive to cope with multiple sample rates with a mixture of clocked and un-clocked sources. This applies particularly to streaming computer audio files with different sample rates, or using an Upsampler with a variety of output sample rates.

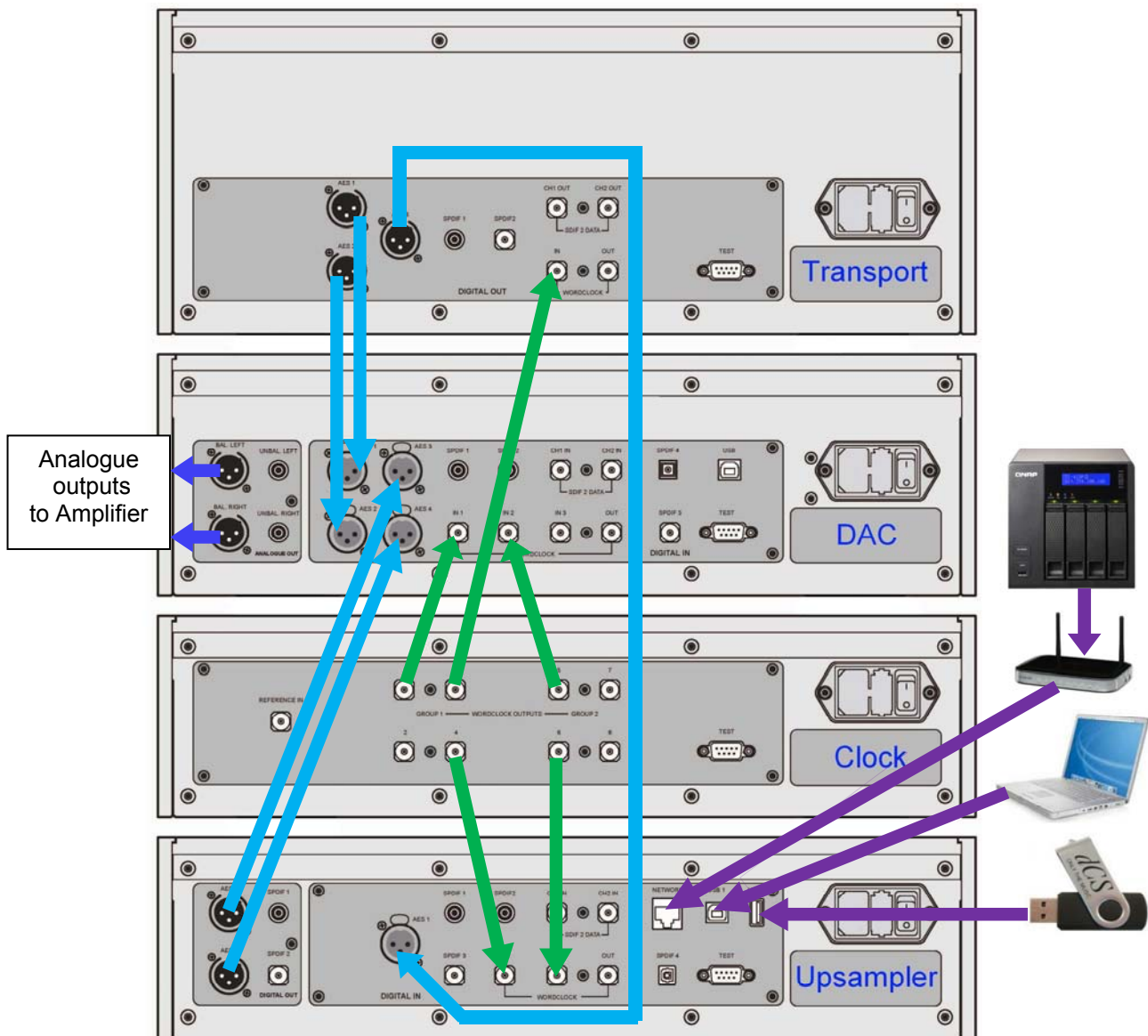

Figure 2 – A 4-box Vivaldi system plus computer audio sources

The system shown above makes excellent use of the Vivaldi's facilities. The Upsampler can be sourced from the Transport, a PC, a NAS drive, an iPod/Phone/Pad or a USB flash drive. The multiple clock connections (shown in green) ensure that the DAC and Upsampler can always access a suitable clock, despite changing file sample rates and changing Upsampler output rates.

The Vivaldi Master Clock has 2 Groups of outputs, each of which can be set to any of 6 standard clock frequencies. The DAC and Upsampler have 3 and 2 Word Clock inputs respectively, to ensure they can have access to a suitable clock despite changing sample rates in the system.

- Set Master Clock **Freq1** to **44.1kHz** and **Freq2** to **48kHz**.
- Connect one of the **Clock Group 1** outputs (44.1kHz) to the **Word Clock Input** of the Transport – it will automatically sync.
- Connect one of the **Clock Group 1** outputs (44.1kHz) to the DAC's **Word Clock In1** input and one of the **Clock Group 2** outputs (48kHz) to the DAC's **Word Clock In2** input.
- Connect one of the **Clock Group 1** outputs (44.1kHz) to the Upsampler's **Word Clock In1** input and one of the **Clock Group 2** outputs (48kHz) to the Upsampler's **Word Clock In2** input.



Set the DAC and Upsampler **Sync Mode** menu pages to **Auto**. Remember that this must be set separately for each active input.

- Connect the Upsampler's **AES1+2** output to the DAC's **AES3+4** input.



The DAC's **AES3+4** input allows commands to tunnel from the Upsampler. The DAC's **AES1+2** input does not.

- Connect the Transport's **AES1+2** output to the DAC's **AES1+2** input.
- Connect the Transport's **AES3** output to the Upsampler's **AES** input.
- Computer audio sources as required can be connected to the Upsampler's Asynchronous **USB** interfaces and a NAS drive may be connected via a router to the Upsampler's **Network** input (also Asynchronous). Please see the Upsampler manual for more information.
- Set the Clock's **Settings > Dither** menu pages **On** or **Off** as you prefer.

Using an External Reference

If you have a GPS receiver or an atomic clock with a 10MHz output, you can lock the Vivaldi Clock to it. These sources are even more accurate than the Vivaldi Clock, but note that low jitter and good stability are more important than absolute accuracy.

- Use another BNC cable to connect the 10MHz output from the external reference to the Vivaldi Clock's **Reference In** connector.
- Open the Clock's menu and set the **Settings > Reference In** menu page to **AC**.



This icon appears when the Clock is locked to an external reference.

- Set the DAC **Volume** control to a suitable level and play some music.

Using sources that cannot lock to Word Clock

You can use a device that does not have a Word Clock input (such as a satellite receiver or a basic CD Transport) in a Vivaldi system, but a different set-up is needed. You cannot lock the DAC or Upsampler to the Master Clock if the source equipment is not also locked to the Master Clock because this breaks Golden Rule 1. This is a very common set-up error.



3-box Vivaldi system: To get around this when using a Vivaldi Transport / DAC / Clock, simply connect the device to one of the DAC's inputs, select that input and set the **Settings > Sync Mode** page to **Audio**.



4-box Vivaldi system: Connect the device to one of the Upsampler's unused inputs (such as **SPDIF1** in or **Toslink**), select that input and set the Upsampler's **Settings > Sync Mode** page to **Audio**.



Next, connect a BNC cable from the Upsampler's **Word Clock Output** to the DAC's **Word Clock In3** input. Connect one of the Upsampler's SPDIF outputs to the DAC's matching input, select that input and set the DAC's **Settings > Sync Mode** page to **Word Clock 3**. Set the Upsampler's **Output** sample rate and play the music. To change between the un-locked device and the Vivaldi Transport (for example), select the relevant inputs on the Upsampler AND the DAC.

FRONT PANEL

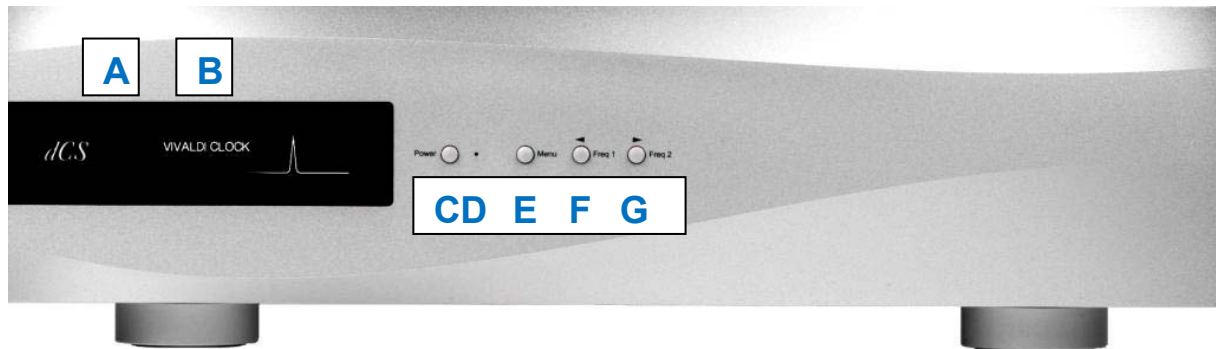

Figure 3 – Front panel

Remote Control Receiver

Aim the remote control handset towards the receiver (A) for best sensitivity.

Display

In normal use, the clock frequencies for **Group 1** (outputs 1-4) and **Group 2** (outputs 5-8) are shown at the top of the display (B), for example:



The **Dither** icon is displayed beside the frequency when the **Dither** menu page for that Group is set to on.

The icons at the bottom show the current settings or operating conditions, these are:



The thermometer icon appears when the temperature of the unit has been stable for the last 2 minutes. Note that the icon may appear and disappear as the room temperature changes during the day and the Clock has to make more fine corrections – this is not a cause for concern.



If the thermometer icon disappears and reappears more frequently than you expect, the temperature of the unit is fluctuating, probably due to a cold or warm draught.



This icon appears when the Clock is locked to an external reference.



The **Locked** icon is displayed when the **Settings > Lock** menu page is set. The clock frequencies cannot be changed while this is displayed.



The **CAL** icon appears when the Clock requires re-calibrating. Please contact your dealer or distributor to arrange servicing.

Details of the menu displays are shown in the Menu section on page **15**.



To avoid unnecessary display wear, we recommend switching off or setting the unit to Sleep mode at the end of the listening session.

Power Button

To switch on, ensure the rear panel switch is set to **I** and press the **Power** button (C) on the front panel once. Note that the unit cannot be turned on from the remote control.

To set the unit to sleep mode, press the **Power** button once. The main display will turn off, the LED (D) beside the button will illuminate and the Word Clock Outputs will be muted, but the unit will remain close to running temperature. Press again to return to normal operation.

To switch off, hold down the **Power** button for about 5 seconds until **SWITCHING OFF** appears on the display, then release it.

When the menu is open, press the **Power** button to close the menu.

Menu Button

Press the **Menu** button (E) to open the menu, select menu pages and change settings. See the Menu section on page **15** for information on using the menu features.

Freq1 Button

Use the **Freq1** button (F) to set the clock frequency for **Group 1** Word Clock outputs. A typical setting is **44.1kHz**.

When the menu is open, the **Freq1** button changes to the ◀ button, used to page backwards through the menu.

Freq2 Button

Use the **Freq2** button (G) to set the clock frequency for **Group 2** Word Clock outputs. A typical setting is **48kHz**.

When the menu is open, the **Freq2** button changes to the ▶ button, used to page forwards through the menu.



When using the automatic clock selection feature on the Vivaldi DAC and Upsampler, it is essential that one Group is set to 44.1kHz and the other Group is set to 48kHz, or exact multiples of these frequencies.

REAR PANEL

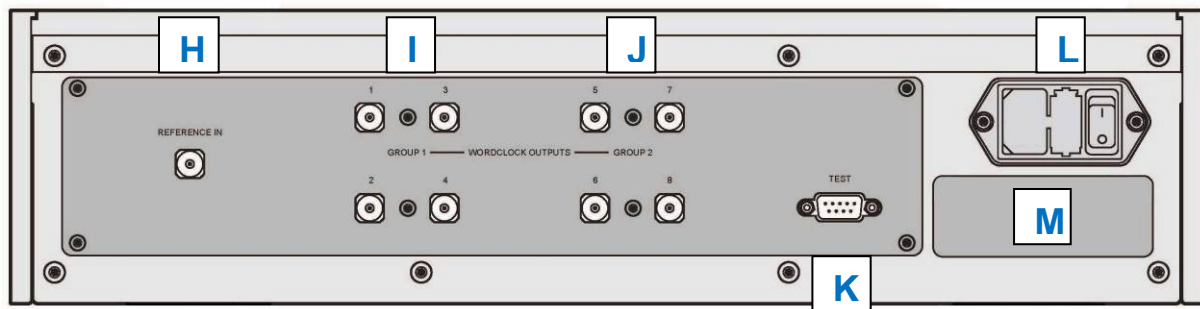

Figure 4 – Rear panel

Reference Input

The **Reference In** connector (H) allows the unit to be locked to an accurate external reference, such as an atomic clock or a GPS receiver.



The unit will automatically lock when a suitable reference is connected and display this icon when locking is complete.

With the **Reference Input** menu page set to **TTL**, the unit will lock to a TTL-compatible word clock. With the **Reference Input** menu page set to **AC**, the unit will lock to an AC-coupled reference.



As the Vivaldi Clock is a grade 1 master clock, there is nothing to be gained by locking it to a less stable or less accurate reference!

During software updating, this input behaves as an SPDIF input.

Word Clock Outputs

The unit has eight **Word Clock Outputs**, which are split into **Group 1** (I) and **Group 2** (J) with 4 outputs in each group. Each group can be set to 44.1, 48, 88.2, 96, 176.4 or 192kHz.

Word clock is used for synchronisation only, it does not carry digital data.

Test interface

This **RS232** interface (K) has two modes, set by the **Settings > RS232** menu page.

- **Binary mode** is used to remotely control the unit during automated production testing at *dCS*.
- **Text mode** is for use with a household automation system. If you would like to use this mode, please download the list of remote control commands from www.dcsLtd.co.uk.

The interface is designed to be used with a “straight through” cable, wired pin 1 to pin 1, etc.

The pin connections are:

- Pin 2 – *dCS* unit transmit
- Pin 3 – *dCS* unit receive
- Pin 5 – ground
- Shell – cable screen & drain wire

Mains inlet

Power is connected via a standard IEC320 connector (L), protected by a fuse and isolated by a 2-pole power switch.

Label

The label (M) states the unit's serial number and the nominal voltage to which the unit is set. It is important to quote the serial number if you need assistance.

THE MENU

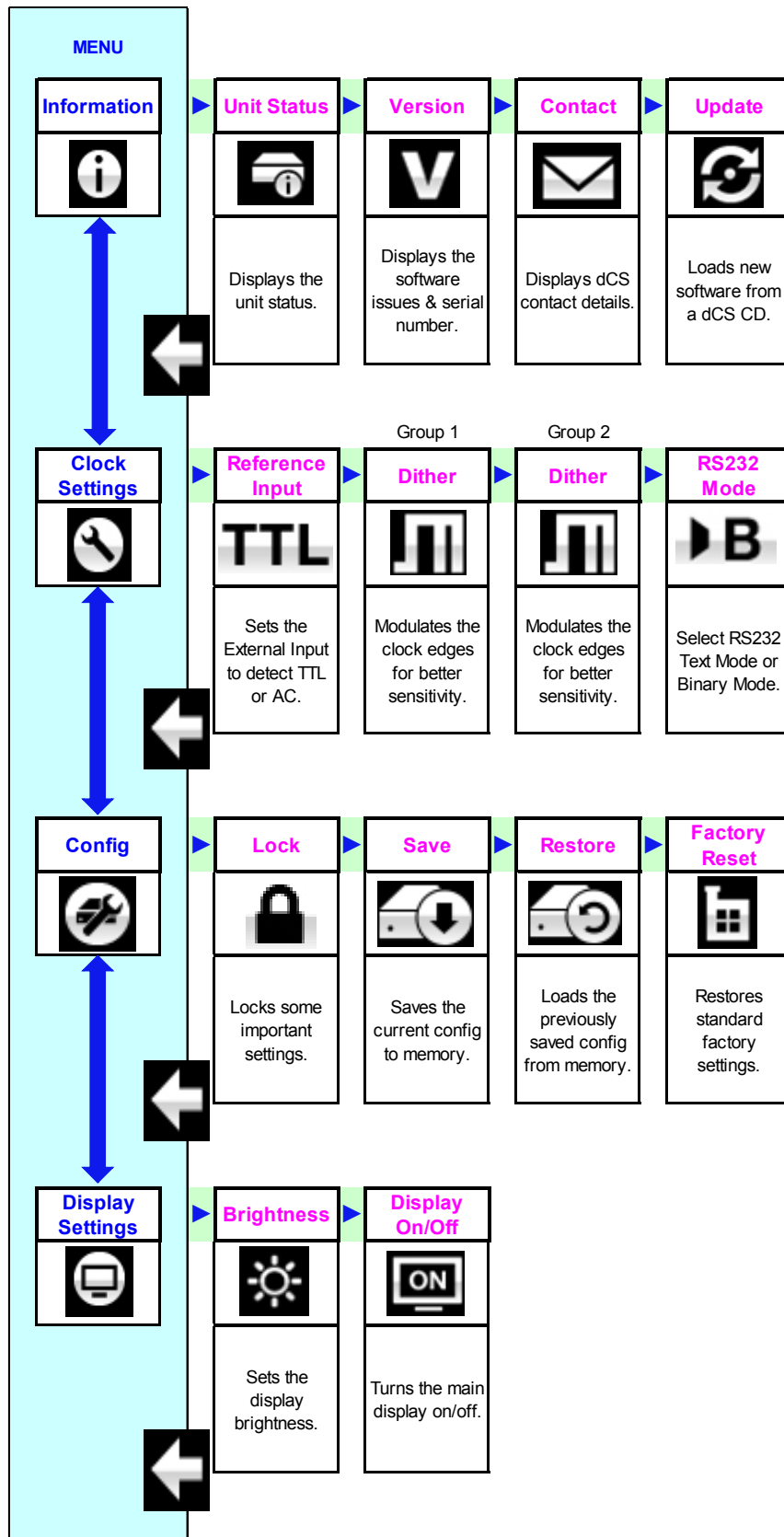

Figure 5 – The menu sequence

Using the Menu

The menu gives the user access to a range of additional features. It also allows new features and performance enhancements to be added later by software updates.

The menu is controlled by four buttons.

- Press the **Menu** button to open the menu or select a setting.
- Press the **▶** button to page forward through the menu.
- Press the **◀** button pages backward through the menu.
- Press the **Power** button to close the menu or just wait 10 seconds.



Use the Menu Guide sheet to help you find the right menu page.

Each unit in the range has either four or five top-level menu pages:



The **INFORMATION** menu gives unit set-up details, software issues, serial number and contact details.



Each model has a different **SETTINGS** menu, which allows you to set some features that are not directly accessible from the front panel.



The **CONFIGURATION** menu allows you to lock important settings, save a standard setup and reset the unit.



The **DISPLAY SETTINGS** menu is used to adjust the display.



The **SIGNAL GENERATOR** menu (featured on the Transport, Upsampler and DAC only) contains test and set-up routines.

Use the **▶** button to move the blue highlight to the menu you want, then press the **Menu** button to select it. The next menu level down is displayed. Use the **▶** button to move the highlight to the menu page you want, then press the **Menu** button to display the information or change the setting.



Select the return icon to go back to the previous menu level.

INFORMATION Menu

Unit Status



The **Unit Status** page displays:

- Serial number (the long version, including the configuration code).
- Temperature:°C, measured in the clock generator.
- Calibrated: yes/no.
- Clock input rateHz, detected at the **Reference Input**.
- Locked to external clock: yes/no

Use the ◀ ▶ buttons to scroll up or down the list. This page does not time out, press the **Menu** button to exit.



If your system is not behaving as you expect, the **Unit Status** page can help you find set-up or connection errors.

Version



The **Version** page displays the software versions loaded in the unit. Please have this information ready if you contact your dealer for any reason:

- Control Board: 1.2x (this is the main software version)
- Front panel: 1.2x

This page does not time out, press the **Menu** button to exit.

Contact



The **Contact** page displays the dCS web-site URL and support email address. This page does not time out, press the **Menu** button to exit.

If you have any difficulty, please contact your dealer for help first.

Update



The **Update** feature allows you to load new software into the unit. Please follow the instructions supplied with the update disc carefully.



If you accidentally start an Update, do not worry. The unit will automatically detect it is not receiving updated software and will abort the process. The software will not have been changed.

CLOCK SETTINGS Menu

Reference In



The **Reference In** menu page sets the **Reference Input** to accept either an **AC** coupled reference (generated by a Rubidium reference or GPS receiver, for example) or...



...a Word Clock signal at **TTL** levels.



If you are not using an external reference, set this page to **TTL**. This setting is much less sensitive to stray signals which could otherwise interfere with the Clock's stability.

Dither



The **Dither** feature modulates the clock edges in a controlled way to exercise the phase-locked-loops in the source and DAC, improving their error correction. Try it and decide for yourself whether you prefer **Dither on** or...



...**Dither off**.

There are separate menu pages for **Dither Group 1** and **Dither Group 2**.

RS232 Mode



RS232 Mode – sets the RS232 interface to either **Text** mode for use with 3rd-party control systems or...



...*dCS* production **Binary** mode, which is intended for factory use only.

CONFIGURATION Menu

Settings Lock



Settings Lock – when set to **Locked**, this icon is displayed and the following settings cannot be changed:

- Group 1 output Frequency
- Group 2 output Frequency
- **RS232 Mode**
- Group 1 Dither
- Group 2 Dither
- **Factory Reset** is disabled.



Set to **Unlocked** if you need to change these settings.

Save Configuration



Once the unit is set up the way you want it, select **Save** to store the settings in memory. If you deliberately change the setup later and want to keep it, select **Save** again to store the changes.

Restore Configuration



If the unit settings are accidentally changed, select **Restore** to reload the settings you saved earlier.

Factory Reset



This page resets the unit to standard settings. These are:

- Output frequencies to **44.1kHz**.
- **Reference In** to **TTL**.
- **Dither** to **Off**.
- **Settings Lock** to **Unlocked**.
- **RS232 Mode** to **Binary**.
- **Brightness** to maximum.
- **Display** to **On**.

DISPLAY SETTINGS Menu

Brightness



Set the display Brightness to a comfortable level using the ◀ or ▶ buttons.

Display On/Off



This page is usually set to **On**.



When set to **Off** and the menu closes, the display will turn off after a few seconds. The display will turn on briefly when a control setting is changed. The display will stay on while the menu is open.

SPECIFICATION

Clock type	Class 1 Master Clock, using dual crystal oscillators with microcontroller-enhanced temperature correction.
Clock Frequencies	44.1, 48, 88.2, 96, 176.4 and 192kHz.
Clock Accuracy	Better than +/-1ppm when shipped, typically +/-0.1ppm when shipped and stabilised. The calibration is tested over a temperature range of +5°C to +55°C.
Word Clock Outputs	8 independently buffered outputs on 75Ω BNC connectors, split into 2 groups that can run at different clock frequencies.
Reference Input	External Reference Input on 1x 75Ω BNC connector. Accepts word clock (with the Reference In menu page set to TTL) or AC coupled signals (with the Reference In menu page set to AC) at 1MHz, 5MHz or 10MHz. Lock range is +/-300ppm.
Start-up time	Typically 1 minute to rated accuracy.
Size and weight	444mm (17.5") long x 435mm (17.2") deep x 126mm (5.0") high. Allow extra depth for cable connectors. Allow space for air flow around the unit. 13.6kg (29.9lbs).
Power requirements	Internally set to either 100, 115/120, 220 or 230/240V AC, 50/60Hz. Power consumption: 10W typical, 50W maximum. Consumes less than 0.5W when powered down from the front panel.

These specifications are subject to change without notice.

MAINTENANCE AND SUPPORT

Service and Maintenance

dCS audio products are designed not to need regular maintenance, and contain no user serviceable parts apart from the mains fuse. If your unit is damaged in any way, please contact your dealer.

Replacing a Blown Mains Fuse

There is a mains fuse below the power inlet, accessible from the outside of the unit. If the fuse blows, it may be changed by the user. The current consumption of the unit is very low, so it only blows if power surges occur, or there is a fault in the unit. Usually power surges cause no other damage, but if the fuse blows repeatedly on replacement, some other damage will have been done - contact your dealer to arrange repair.

Fuse type: 20 x 5mm T 1A L fuse



If the fuse should fail, it is essential that it is replaced with one of the same type and rating. Failure to do so could result in damage to the unit, risk of fire or electric shock and will invalidate the warranty. Fuse failure is rare!

Referring to the diagram below, remove the power cable, use your fingernails to catch the two tabs of the fuse holder (A), push them together to release the clips and pull the fuse holder out. Pull out the blown fuse from the lower position (B) and discard it. Either move the Spare Fuse (C) to the lower position or fit one of the fuses from the manual pack. Orient the fuse holder as shown (D) and push the holder back into the power inlet so that it clicks home.

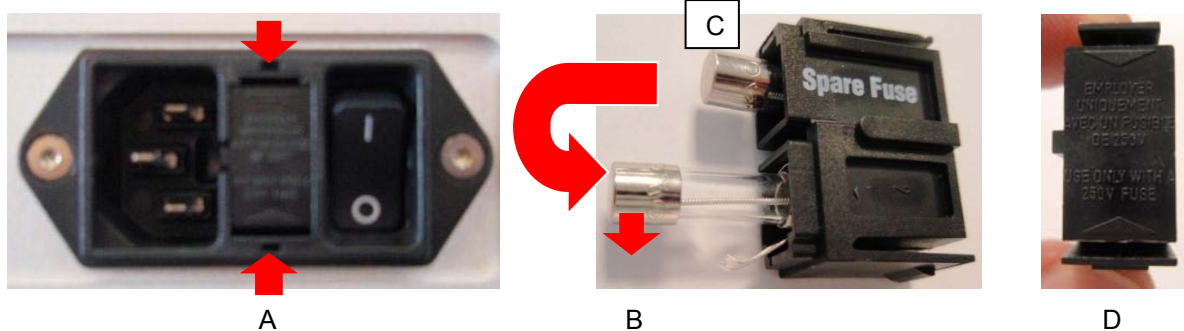

Cleaning the case

The front and back panels of your dCS equipment are machined from very high grade aluminium. Great care has been taken to create the finish of the aluminium throughout the engineering process from the raw solid material to the finished piece.

To remove loose dust or finger marks from the case, we recommend that you use a clean, dry, lint-free cloth.

To restore the finish, we recommend applying small quantities of a lanolin based cleaner, using a clean, dry, lint-free cloth and then wiping off. Do not allow lanolin to collect around the buttons.

Small amounts of glass cleaner containing ammonia may be used to clean other surfaces, but avoid spraying onto the connector contacts.

Limited Warranty

General

dCS warrants this product against defects in materials and workmanship for a period of 3 years from the date the unit was originally shipped from dCS. If the product is purchased and registered with dCS within 6 months of the date the unit was originally shipped from dCS, we will start the warranty on the purchase date. For units registered later than 6 months from the ship date, we will start the warranty from the ship date unless the registration is supported by the original sales invoice. During the warranty period, dCS will repair or, at our absolute discretion, replace a faulty product. Warranty repairs must only be carried out by dCS or our authorised service agents. Please contact your dealer if your unit requires service.

To register this product, either register online at www.dcsltd.co.uk or complete the **Product Registration** form within 30 days of the sale and return it to dCS. On receipt of the registration, dCS will add your contact details to our customer database. dCS will use this information for warranty purposes only, we will not contact you directly for reasons relating to sales and marketing.

This warranty applies to the original owner, it is not transferable.

Warranty Exclusions

The Warranty does not cover wear and tear.

The Warranty on this product will be void if:

- the product is misused in any way.
- any unauthorised modifications or repairs are carried out.
- the product is not used in accordance with the Operating Conditions stated in this **manual**.
- the product is serviced or repaired other than by dCS or our authorised service agents.
- the product is operated without a mains earth (or ground) connection.
- the unit is returned inadequately packed.

dCS reserve the right to apply a service charge if a product returned for warranty repair is found to be operating correctly, or if a product is returned without a returns number being issued.

This warranty covers parts and labour only, it does not cover shipping charges or tax/duty.

Our dealers or distributors are NOT authorised to extend the terms of this warranty, dCS cannot accept responsibility for any attempt to do so.

Products re-sold by dCS on a “used” basis may be subject to reduced warranty terms.

Obtaining Service

Should you encounter a problem, contact your authorised dCS dealer for advice, quoting the model, the full serial number, software version number, and giving a detailed description of the fault. Your dealer will advise you fully on actions that need to be taken. When returning a unit, the original packaging should be used to avoid transit damage. Replacement packaging sets may be purchased from dCS.

During the Warranty period, there will normally be no charge for parts or labour.

Operating Conditions

- The supply voltage must remain within +/-10% of the A.C. voltage specified on the back panel.
- The supply frequency must be in the range 49Hz to 62Hz.
- Ambient temperature range: 0°C (32°F) to 45°C (113°F), non-condensing.
- Do not install the unit near heat sources such as radiators, air ducts, power amplifiers or direct strong sunlight.
- If in doubt, the easy test is – the unit is happy to work anywhere a human is.

If you need more help

In the first instance, you should contact your dealer. If they cannot resolve the issue, contact your national distributor.

Manufactured by:

Data Conversion Systems Ltd.
Unit 1, Buckingham Business Park,
Anderson Road,
Swavesey,
Cambridgeshire. CB24 4AE
UK

www.dcsLtd.co.uk

This user manual may be downloaded free of charge from our web-site.

A bound copy of this manual may be ordered from *dCS*.

Software History

dCS products make extensive use of software configurable chips – FPGAs and DSPs. This gives us the ability to update our products to add extra features, update digital interface standards or make performance improvements by loading new software. Occasionally, a hardware update may be necessary also to increase the “capacity” of the electronics, add extra connectors or extra front panel controls.

Please note that not all software updates produce an audible improvement. We recommend that you keep your software up to date. Check the *dCS* web-site occasionally for news of the latest software updates.



Update discs are available from our distributors. Before requesting an update disc, please open the **Info > Version** menu page and check the **Control Board** version to verify that an update is actually needed.

This manual is for **Vivaldi Clock** software version 1.2x.

Issue 1.00	The first issue.
Issue 1.01	Reliability improvement.
Issue 1.10	Configuration menu added, with Settings Lock, Save & Restore Configuration. RS232 Binary commands added for set Group 1 output frequency to 88.2, 96, 176.4 & 192kHz, set Group 2 output frequency to 44.1, 48, 88.2, 96, 176.4 & 192kHz, Dither 1 on/off, Dither 2 on/off, Sleep, Wake & Power Down. Allow RS232 Text mode to set output frequency. Various minor bugs fixed.
Issue 1.20	More RS232 Text mode commands added.
Issue 1.21	Adds compatibility with a newer hardware version (no performance changes).

INDEX**C**

cables	7
CAL.....	11
CD/SACD system	8
cleaning	21
configuration	
restore	19
save.....	19
configuration menu	19
contact	17

D

display.....	11
brightness	19
off	19
display menu	19
dither.....	11, 18

E

external reference.....	10
-------------------------	----

F

feet.....	4
freq1 button	12
freq2 button	12
frequency	12
front panel.....	11
full system.....	9
fuse, replacing	21

G

group.....	13
------------	----

I

information menu.....	17
-----------------------	----

L

lock	11, 19
------------	--------

M

menu.....	15
close.....	12
configuration	19
display.....	19
information	17
settings.....	18
using	16
menu back button	12
menu button.....	12
menu forward button	12

O

operating conditions	22
----------------------------	----

P

positioning	4
power button.....	12
power off.....	12
power up.....	7

R

rear panel	13
reference input.....	11, 13, 18
remote control.....	11
reset.....	19

restore configuration.....	19
RS232.....	13, 18
rules for master clock	7

S

safety	5, 6
save configuration	19
serial number.....	14
service	21
settings menu	18
setup guide.....	7
sleep	12
software	17, 23
specification.....	20
status	17

T

temperature stable	11
--------------------------	----

U

unclocked sources.....	10
update.....	13, 17, 23

V

version	17
voltage.....	14

W

wake	12
warranty.....	22
word clock output	13