

***dCS* Rossini Clock**  
Digital Audio Master Clock

**User Manual**  
Software Release 1.0x  
February 2016

© Data Conversion Systems Ltd. 2015-2016

Price UK £10.00

All rights reserved. No part of this publication may be reproduced, stored in or introduced into a retrieval system, or transmitted in any form, or by any means (electronic, mechanical, photocopying, recording or otherwise) without the prior written permission of *dCS*<sup>1</sup>. Any person who does any unauthorised act in relation to this publication may be liable to criminal prosecution and civil claims for damages.

Information contained in this manual is subject to change without notice, and whilst it is checked for accuracy, no liabilities can be accepted for errors.

---

<sup>1</sup> *dCS* is Data Conversion Systems Ltd. Company registered in England No. 2072115.



## Contents

<b>Using the dCS Rossini Master Clock for the first time .....</b>	<b>4</b>
What's in the box?	4
Positioning the unit	4
Safety Notice	5
<b>Step-by-Step Guide .....</b>	<b>6</b>
Preliminaries	6
The GOLDEN RULES for using a Master Clock	6
Using the Rossini Player or DAC with the Clock	7
Using the Rossini DAC and Clock with a Transport	8
Using the Rossini Player or DAC and Clock with other sources	9
Power Link	10
RS232 Control	10
<b>Front Panel .....</b>	<b>11</b>
Dither Buttons	11
Power Button	11
<b>Rear Panel .....</b>	<b>12</b>
Label	12
Word Clock Outputs	12
RS232 Interface	12
Mains inlet	12
<b>Specification .....</b>	<b>13</b>
<b>Maintenance and Support.....</b>	<b>14</b>
Service and Maintenance	14
Replacing a Blown Mains Fuse	14
Cleaning the case	14
Limited Warranty	15
If you need more help	16
Software	16
<b>Index .....</b>	<b>17</b>

---

## USING THE *dCS* ROSSINI MASTER CLOCK FOR THE FIRST TIME

Congratulations on purchasing your *dCS* Rossini Master Clock.

Before using your unit, please read this section and the Step by Step Guide. This will enable you to set the unit up quickly and safely with your hi-fi system.

### What's in the box?

Check that the box contains the following items:

- *dCS* Rossini Master Clock
- Manual
- Power cable
- 2x BNC cables
- Spare fuses

Notify your dealer as soon as possible if anything is missing or damaged. We suggest that you retain the original packaging for possible future use. If this is not possible, replacement packaging can be ordered from *dCS* or our distributors. Details can be found on our web site at [www.dcsLtd.co.uk](http://www.dcsLtd.co.uk).

### Positioning the unit

For best sound quality, the units in the Rossini range are designed to be mounted on separate shelves of a rack, although they may be stacked directly on top of each other if this is absolutely necessary. Place each unit on a firm, vibration free base, allowing convenient connection to the other parts of your system. To prevent overheating, we recommend that you leave some free space around the unit to allow for ventilation.



With all feet screwed fully home, the unit will sit level on a flat surface. If you need to do any levelling, you can unscrew any of the feet up to 3 complete turns, to give up to 3mm (1/8") of height adjustment.

## Safety Notice



Your *dCS* Rossini Master Clock contains no user serviceable parts. **DO NOT** attempt to open the case as there are potentially dangerous voltages present inside. In the event of the unit developing a fault, please contact your dealer in the first instance.

If you decide to remove safety covers for any reason, disconnect the power cable first. Note that removing covers voids the warranty.

To maintain protection from electric shock, the unit **MUST** be connected to mains earth (ground) via the power cable. Also, unearthed systems do not give the best sonic performance.

Protect the product from dripping or splashing liquids. Liquid-filled objects such as vases must not be placed on the product.



This product is not suitable for operation at altitudes above 2000m.



This product is lead-free and complies with the RoHS directive.

Before connecting the power cable to the unit for the first time, please check that it has been set to the correct operating voltage for your mains supply. The unit's voltage setting is shown on the serial number label. If this does not match your local supply voltage, **DO NOT** attempt to use the unit. Contact your dealer to have the unit reset. Using the unit with the wrong mains setting for your local supply may result in serious damage to the unit and will invalidate the warranty. Do not attempt to reset the voltage yourself.

We do not recommend the use of mains regenerators. However, if you do wish to use a mains regenerator with variable voltage and frequency, we recommend that you set the voltage to match your local voltage and the frequency to either 50Hz or 60Hz **ONLY**.



Damage caused to your Rossini Master Clock by misuse of a mains regenerator or by a malfunctioning mains regenerator is not covered by the warranty.



Disposal at end-of-life - the symbol indicates that this product should not be treated as normal household waste. It should be recycled, so please take it to an approved collection facility.

## STEP-BY-STEP GUIDE

This section guides you through setting up the unit for basic operation.

### Preliminaries

For the **Word Clock Outputs**, use 75Ω coax cables fitted with BNC plugs.

Connect the power cable supplied to the power inlet on the Clock rear panel, plug the other end into a convenient power outlet.



Make sure that you have access to the unit's rear panel power switch or a switch on the mains outlet, in case a serious failure prevents switching off from the front panel.

Please do not use an excessively heavy or inflexible power cable as this may damage the power inlet connector.



The cables supplied with the unit are "commercial grade", because most owners will have their own "audiophile grade" cables or will prefer to make their own cable choices.

Set the rocker switch near the mains inlet to the **I** position. Press the **Power** button - the Power LED will illuminate. Wait about 30 seconds while the Clock settles.

### The GOLDEN RULES for using a Master Clock

The Rossini system is primarily designed for computer audio or CD Playback. The Rossini Clock is deliberately simpler than a standard dCS Master Clock but it uses the same ultra-stable calibration system. The GOLDEN RULES still apply, but we have found ways to "bend" them!

#### 1. The source equipment **MUST** be locked to the Master Clock.

If it is not, you will either have locking difficulties or hear occasional clicks or drop-outs and the advantages of using the Clock will be lost.



When the Rossini Player / DAC's asynchronous Network or USB inputs are selected, the Player / DAC behaves as the source equipment.

#### 2. The clock frequency **MUST** match the sample rate(s) used in the system.

If it does not, the system cannot lock and the Player / DAC may remain muted. Please check the manuals for the equipment used in your system.

44.1kHz Word Clock is compatible with digital data sampled at 44.1, 88.2, 176.4 or 352.8kS/s or DSD.

48kHz Word Clock is compatible with digital data sampled at 48, 96, 192 or 384kS/s.



The Rossini Player and DAC have 2 Word Clock Inputs, so that they can be supplied with both 44.1kHz and 48kHz clocks. When set to "W" sync, the Player or DAC can automatically select the correct clock frequency and multiply it to match the data.

## Using the Rossini Player or DAC with the Clock

The Rossini Master Clock is primarily designed for use with the Rossini Player or DAC to enhance performance when using the **Network** and **USB** inputs. The Clock can also be used with the Rossini Player for improving CD playback.

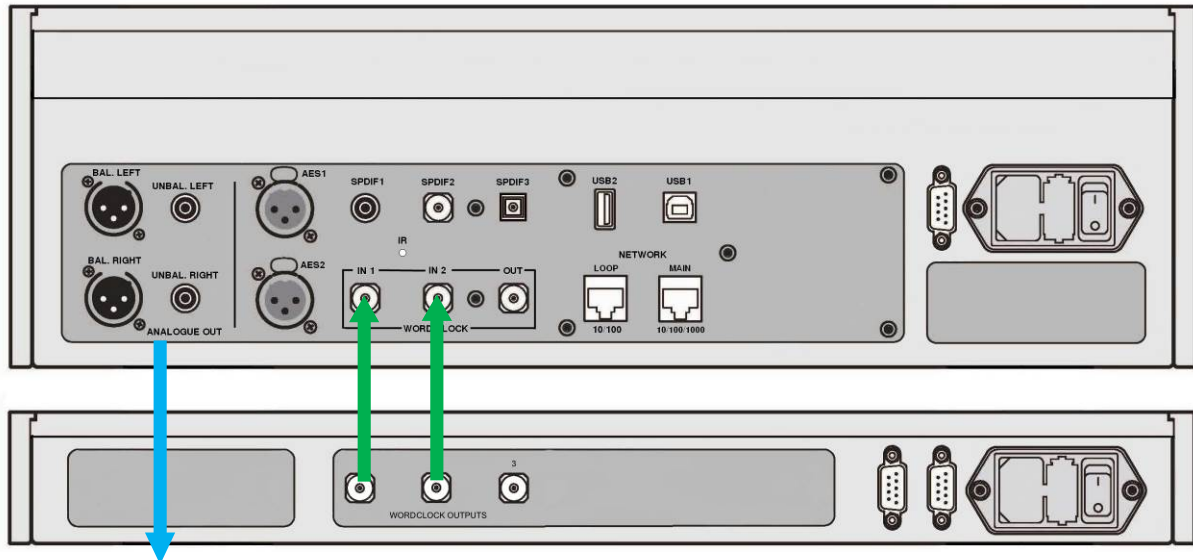

Analogue outputs to  
pre- or power amplifier

Figure 1 – Using the Rossini Player and Clock together

- Connect the system as shown above. The DAC connects in the same way.
- Use the Player's **Input** button to select **CD** mode.



Open the Player's menu, navigate to the **Settings > Sync Mode** menu page (the button sequence is: **Menu**, **▶**, **Menu**). Use the **Menu** button to select the **Word Clock 1** icon.

The Player will re-lock and un-mute.

- Either wait for the menu to close or press the Player's Power button briefly to close it.
- Use the Player / DAC's **Input** button to select the Network input.



Open the Player / DAC's menu, navigate to the **Settings > Sync Mode** menu page again. Use the **Menu** button to select the **Word Clock 1 -2 Auto** icon. Close the menu.

- If you are using the **USB1** or **USB2** inputs, lock them to the Clock in the same way as for the Network input.
- Try turning on the Clock's Dither features.

## Using the Rossini DAC and Clock with a Transport

The Rossini Clock has a third output (normally fixed at 44.1kHz), which may be used to synchronise another source, such as an SACD Transport.

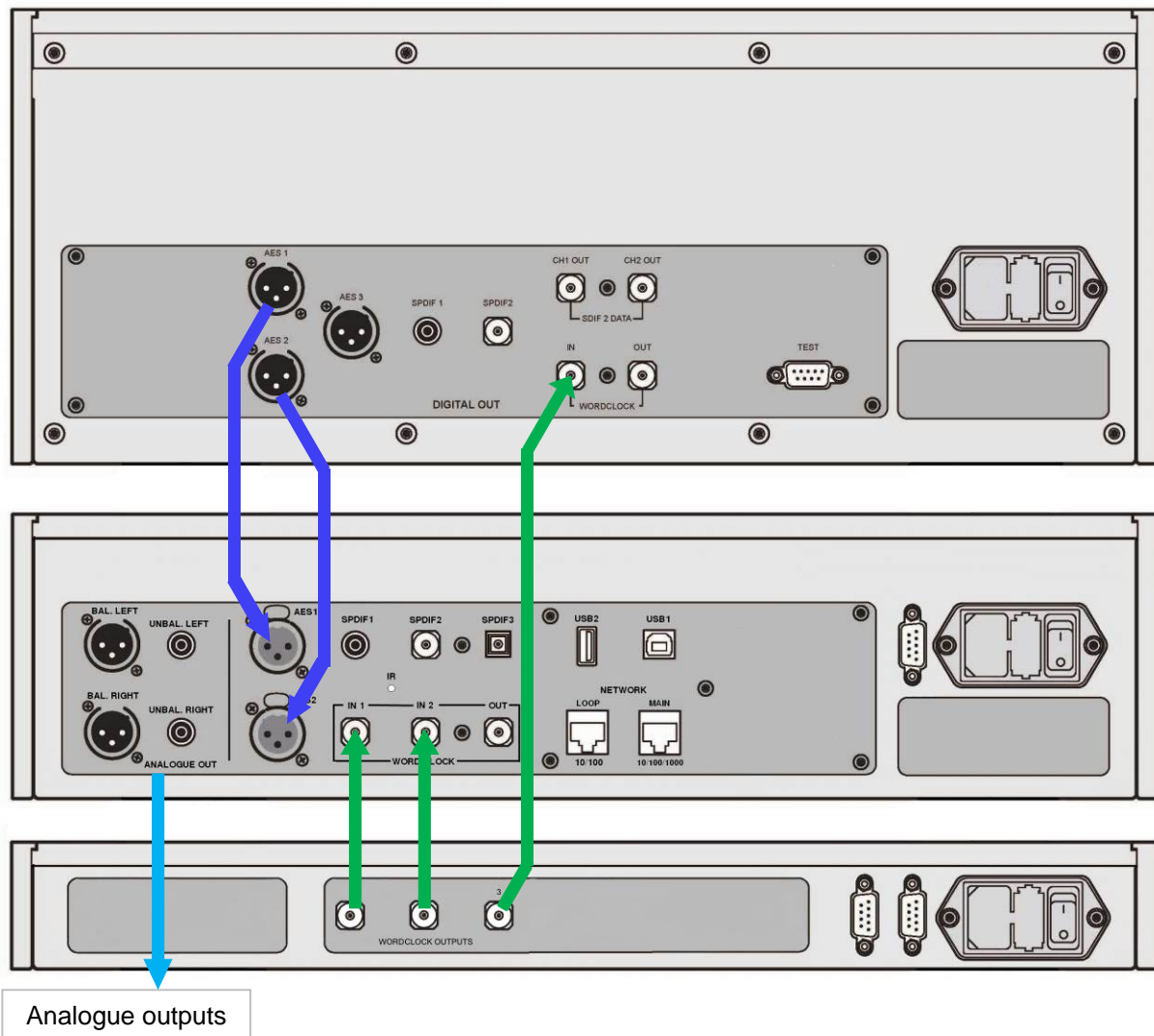

Analogue outputs

Figure 2 – Using the Rossini DAC and Clock with a Vivaldi Transport

- Connect the system as shown above.
- Use the DAC's **Input** button to select the input you want to use (**AES1+2** in the example).



Set the DAC's **Unit Settings > Sync Mode** menu page to **Word Clock 1-2 Auto** mode.



The Vivaldi Transport will lock to the word clock and display this icon.

- If you want to listen to CD playback in native 16/44.1 format, connect one of the Transport's SPDIF outputs to the DAC's matching input. Note that the Transport's PCM outputs must be turned on. Select that input and set it to Master Mode also.



**Output 3** resets to 44.1kHz when the Clock powers up.

The Rossini Player will also work in this setup.



## Using the Rossini Player or DAC and Clock with other sources

The Clock can be used with other sources that have a Word Clock Input and can accept standard word clock. The setup is basically the same as for the Transport on the previous page.

The frequency at **Output 3** can be changed to either 48 or 44.1kHz by RS232 commands to match changing data rates. The data rate must be an exact multiple of this to comply with Rule 2.

**Output 3** resets to 44.1kHz when the Clock powers up.



Other digital audio sources that do not have a Word Clock Input, such as Blu-Ray players or satellite receivers, cannot be locked to the Rossini Clock.

To comply with Rule 1, the Player / DAC input driven by these sources must be set to [Unit Settings > Sync Mode > Audio](#).

The Aurender W20 server can control the frequency of the Rossini Clock's **Output 3** via their RS232 control dongle. Please see the W20 manual for details.

## Power Link

Connecting the Player or DAC's RS232 port to the Rossini Clock's **RS232 Loop** port allows both units to be set to sleep / wake / off by pressing the Player or DAC's **Power** button, or by one remote control command.

Both units must be in the same RS232 mode (Binary or Text). As the Clock boots up in Binary mode, set the Player or DAC's **Unit Settings > RS232** menu page to **Binary**.

A screened cable fitted with two 9-way female D-type connectors wired pin-to-pin is required.

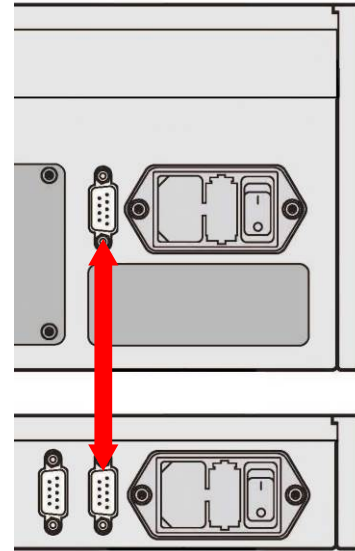

## RS232 Control

The Clock's settings can be changed using a control system or a computer running a terminal emulator program. The procedure using a Windows PC with TeraTerm is described here, but other programs such as PuTTY or ZTerm can be used. If you have difficulty with this, please ask your Dealer for help.

- Hold down the Clock's **Dither 1** button and power up the Clock. This sets the Clock to RS232 Text mode.
- Power up a Windows PC.
- If necessary, download Tera Term from <http://en.sourceforge.jp/projects/tssh2/releases/> and install it on your PC. (If the link is broken, please search for Tera Term online.)
- Use a USB-to-RS232 adapter cable to connect the Clock's **RS232 IN** port to one of the PC's USB ports.
- Run ttermpro.exe.
- Click the **Serial** button – Tera Term will automatically select the port connected to the Clock. Click **OK**.
- Click **Setup > Serial Port**, set the panel as shown with the **Baud rate** set to **115200** and click **OK**.
- Commands are in UPPERCASE only, type **HELP** to list the available commands.

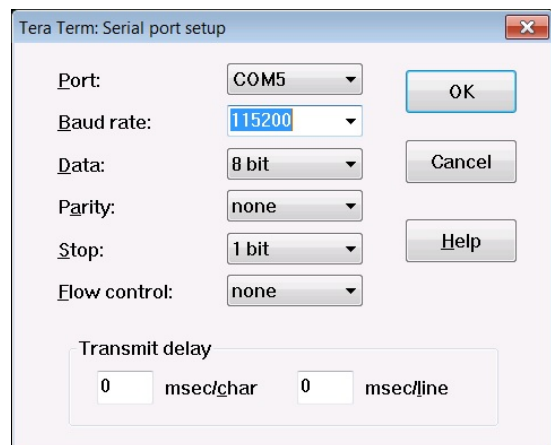

## FRONT PANEL

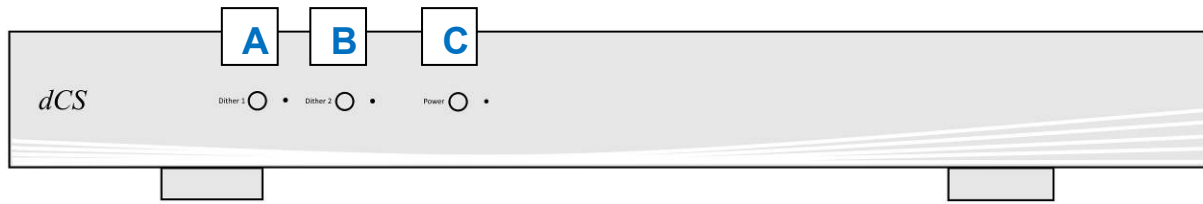

Figure 3 – Front panel

### Dither Buttons

The Dither feature is designed to exercise the Phase-Locked-Loop in the Player / DAC to improve the correction of small timing errors. Try it and see what you think!

Press one or both of the **Dither** buttons (A & B) to turn the Dither feature off and on. When Dither is on, the LED to the right of the button will illuminate.

**Dither 1** affects Word Clock **Output 1**; also **Output 3** if it is set to 44.1kHz.

**Dither 2** affects Word Clock **Output 2**; also **Output 3** if it is set to 48kHz.

### Power Button

To switch on, ensure the rear panel switch is set to **I** and press the **Power** button (C) on the front panel once.

To set the unit to sleep mode, press the **Power** button once. The LED beside the button will dim and the Word Clock Outputs will be muted, but the unit will remain close to running temperature. Press again to return to normal operation.

To switch off, hold down the **Power** button for few seconds until the LED turns off, then release it.

## REAR PANEL

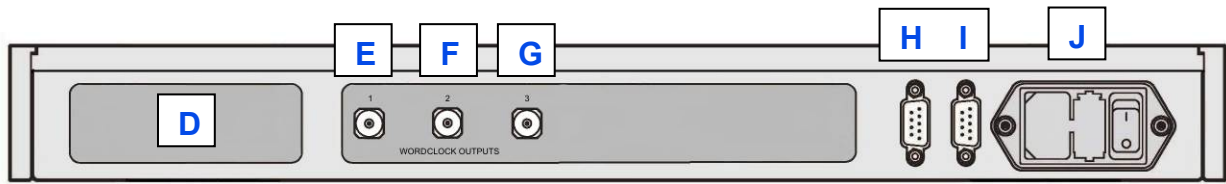

Figure 4 – Rear panel

### Label

The label (D) states the unit's serial number and the nominal voltage to which the unit is set. It is important to quote the serial number if you need assistance.

### Word Clock Outputs

The unit features three **Word Clock Outputs**:

- Output **1** (E) generates 44.1kHz.
- Output **2** (F) generates 48kHz.
- Output **3** (G) is set to 44.1kHz at power up, it can be set to either 44.1 or 48kHz by RS232 commands.

Word Clock is used for synchronisation only, it does not carry digital audio data.

### RS232 Interface

RS232 interface on 2x 9-way male D-type connectors. The **Input** connector (H) is driven from a controller device, the **Loop** connector (I) loops through to the Rossini Player or DAC.

The interface is designed to be used with "straight through" cables, wired pin 1 to pin 1, etc.

The pin connections are:

- Pin 2 – *dCS* unit transmit
- Pin 3 – *dCS* unit receive
- Pin 5 – ground
- Shell – cable screen & drain wire

When the Clock is looped through to the Rossini Player / DAC, pressing the **Power** button on the Player / DAC sends an RS232 command to set the Clock to Sleep / Wake / Off also. Both units must be in the same RS232 mode (Binary or Text) – the Clock always powers up in Binary mode.

### Mains inlet

Power is connected via a standard IEC320 connector (J), protected by a fuse and isolated by a 2-pole power switch.

**SPECIFICATION**

<b>Clock type</b>	Class 1 Master Clock, featuring dual crystal oscillators with microcontroller-enhanced temperature correction.
<b>Clock Frequencies</b>	44.1 and 48kHz.
<b>Clock Accuracy</b>	Better than +/-1ppm when shipped, typically +/-0.1ppm when shipped and stabilised. The calibration is stable over a temperature range of +5°C to +55°C.
<b>Word Clock Outputs</b>	Three independently buffered, TTL-compatible outputs on 75Ω BNC connectors. <ul style="list-style-type: none"> <li>• Output 1: fixed at 44.1kHz</li> <li>• Output 2: fixed at 48kHz</li> <li>• Output 3: set to 44.1kHz at power up, RS232 controllable.</li> </ul>
<b>Start-up time</b>	Typically 1 minute to rated accuracy.
<b>Size and weight</b>	444mm (17.5") long x 435mm (17.2") deep x 64mm (2.6") high. Allow extra depth for cable connectors.  8.3kg (18.3lbs).
<b>Power requirements</b>	Internally set to either 100, 115/120, 220 or 230/240V AC, 49 – 62Hz. Power consumption: 3W typical, 50W maximum. Consumes less than 0.5W when powered down from the front panel.

These specifications are subject to change without notice.

## MAINTENANCE AND SUPPORT

### Service and Maintenance

dCS audio products are designed not to need regular maintenance, and contain no user serviceable parts apart from the mains fuse. If your unit is damaged in any way, please contact your dealer.

### Replacing a Blown Mains Fuse

There is a mains fuse below the power inlet, accessible from the outside of the unit. If the fuse blows, it may be changed by the user. The current consumption of the unit is very low, so it only blows if power surges occur, or there is a fault in the unit. Usually power surges cause no other damage, but if the fuse blows repeatedly on replacement, some other damage will have been done - contact your dealer to arrange repair.

Fuse type: 20 x 5mm T 1A L fuse



If the fuse should fail, it is essential that it is replaced with one of the same type and rating. Failure to do so could result in damage to the unit, risk of fire or electric shock and will invalidate the warranty. Fuse failure is rare!

Referring to the diagram below, remove the power cable, use your fingernails to catch the two tabs of the fuse holder (A), push them together to release the clips and pull the fuse holder out. Pull out the blown fuse from the lower position (B) and discard it. Either move the Spare Fuse (C) to the lower position or fit one of the fuses from the manual pack. Orient the fuse holder as shown (D) and push the holder back into the power inlet so that it clicks home.

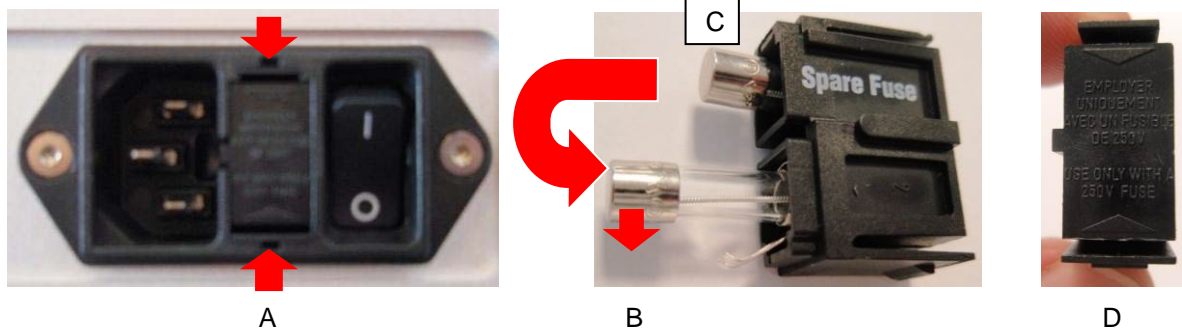

### Cleaning the case

The case of your dCS equipment is machined from very high grade aluminium. Great care has been taken to create the finish of the aluminium throughout the engineering process from the raw solid material to the finished piece.

To remove loose dust or finger marks from the case, we recommend that you use a clean, dry, lint-free cloth.

To restore the finish, we recommend applying small quantities of a lanolin based cleaner, using a clean, dry, lint-free cloth and then wiping off. Do not allow lanolin to collect around the buttons.

Small amounts of glass cleaner containing ammonia may be used to clean other surfaces, but avoid spraying onto the connector contacts.

## Limited Warranty

### General

dCS warrants this product against defects in materials and workmanship for a period of 3 years from the date the unit was originally shipped from dCS. If the product is purchased and registered with dCS within 6 months of the date the unit was originally shipped from dCS, we will start the warranty on the purchase date. For units registered later than 6 months from the ship date, we will start the warranty from the ship date unless the registration is supported by the original sales invoice. During the warranty period, dCS will repair or, at our absolute discretion, replace a faulty product. Warranty repairs must only be carried out by dCS or our authorised service agents. Please contact your dealer if your unit requires service.

To register this product, either register online at [www.dcsltd.co.uk](http://www.dcsltd.co.uk) or complete the **Product Registration** form within 30 days of the sale and return it to dCS. On receipt of the registration, dCS will add your contact details to our customer database. dCS will use this information for warranty purposes only, we will not contact you directly for reasons relating to sales and marketing.

This warranty applies to the original owner, it is not transferable.

### Warranty Exclusions

The Warranty does not cover wear and tear.

The Warranty on this product will be void if:

- the product is misused in any way.
- any unauthorised modifications or repairs are carried out.
- the product is not used in accordance with the Operating Conditions stated in this manual.
- the product is serviced or repaired other than by dCS or our authorised service agents.
- the product is operated without a mains earth (or ground) connection.
- the unit is returned inadequately packed.

dCS reserve the right to apply a service charge if a product returned for warranty repair is found to be operating correctly, or if a product is returned without a returns number being issued.

This warranty covers parts and labour only, it does not cover shipping charges or tax/duty.

Our dealers or distributors are NOT authorised to extend the terms of this warranty, dCS cannot accept responsibility for any attempt to do so.

Products re-sold by dCS on a "used" basis may be subject to reduced warranty terms.

### Obtaining Service

Should you encounter a problem, contact your authorised dCS dealer for advice, quoting the model, the full serial number, software version number, and giving a detailed description of the fault. Your dealer will advise you fully on actions that need to be taken. When returning a unit, the original packaging should be used to avoid transit damage. Replacement packaging sets may be purchased from dCS.

During the Warranty period, there will normally be no charge for parts or labour.

### Operating Conditions

- The supply voltage must remain within +/-10% of the A.C. voltage specified on the back panel.
- The supply frequency must be in the range 49Hz to 62Hz.
- Ambient temperature range: 0°C (32°F) to 45°C (113°F), non-condensing.
- Do not install the unit near heat sources such as radiators, air ducts, power amplifiers or direct strong sunlight.
- If in doubt, the easy test is – the unit is happy to work anywhere a human is.

## If you need more help

In the first instance, you should contact your dealer. If they cannot resolve the issue, contact your national distributor.

Manufactured by:

Data Conversion Systems Ltd.  
Unit 1, Buckingway Business Park,  
Anderson Road,  
Swavesey,  
Cambridgeshire. CB24 4AE  
UK

[www.dcsLtd.co.uk](http://www.dcsLtd.co.uk)

This user manual may be downloaded free of charge from our web-site.

A bound copy of this manual may be ordered from *dCS*.

## Software

The **Rossini Master Clock** does not have a display. The software version currently loaded can be checked by connecting the RS232 interface to a PC running terminal software (e.g. TeraTerm) set for 4800 baud and powering up.

Unlike most other *dCS* products, the Clock does not have the CD Update feature. When new Clock software is available, your unit can be updated by the distributor for your country via RS232. Please visit our web-site to find your distributor. Occasionally, a hardware upgrade may be necessary also to increase the “capacity” of the electronics.

Please note that not all software updates produce an audible improvement. We recommend that you keep your software up to date. Check the *dCS* web-site occasionally for news of the latest software updates.

This manual is for Rossini Master Clock software version 1.0x.

Issue 1.00	The first issue.
------------	------------------



**INDEX****A**

Aurender dongle ..... 9

**C**

cables ..... 6

cleaning ..... 14

clocking a transport ..... 8

clocking another source ..... 9

contact ..... 16

**D**

dither buttons ..... 11

**F**

frequency ..... 12

front panel ..... 11

fuse, replacing ..... 14

**M**

mains inlet ..... 12

**O**

operating conditions ..... 15

**P**

positioning ..... 4

power button ..... 11

power link ..... 10, 12

power off ..... 11

power up ..... 6

**R**

rear panel ..... 12

remote control ..... 12

RS232 control ..... 10

RS232 interface ..... 12

rules for master clock ..... 6

**S**

safety ..... 5

serial number ..... 12

service ..... 14, 15

set Text mode ..... 10

setup guide ..... 6

sleep ..... 11

software ..... 16

specification ..... 13

system setup ..... 7

**V**

voltage ..... 12

**W**

wake ..... 11

warranty ..... 15

word clock output ..... 12