



Summary

Present document resumes the results obtained during the modal and static tests performed by Vicoter on Golia rack produced by Bassocontinuo.



Index

1. Introduction	4
2. Modal analysis	5
2.1 Experimental setup	5
2.2 Results	8
3. Static tests	18
3.1 Experimental setup	18
3.2 Results	21

1. **Introduction**

Vicoter tested Golia rack manufactured by Bassocontinuo and belonging to the Ultimate Line (Figure 1). Following test were performed:

1. Modal analysis.
2. Static test under compression.

The purpose of the tests was the characterization of the rack both from a dynamic point of view up to 2000 Hz (i.e. the measurement of its resonance frequencies and its modal shapes), and from a static one.

Obtained results are described in the following.



Figure 1. Golia rack.

2. **Modal analysis**

2.1 **Experimental setup**

Modal tests are performed with the following instrumentation:

- 1 SCADAS 316 front-end for signal conditioning and acquisition.
- 25 PCB 333B32 uniaxial accelerometers, bandwidth from 0.5 Hz to 3 kHz and full-scale equal to 50 g.
- 15 PCB 352C33 uniaxial accelerometers, bandwidth from 0.5 Hz to 10 kHz and full-scale equal to 50 g.
- 5 PCB 356B08 triaxial accelerometers, bandwidth from 0.5 Hz to 5 kHz and full-scale equal to 50 g.
- 1 instrumented hammer with a PCB 086B03 load cell, to excite the structure. The hammer is equipped with a soft tip able to excite the band up to 2048 Hz.
- Software LMS-TestLab, release 17, for data-processing.

The rack is instrumented in 55 points. Corresponding wireframe is shown in Figure 2.

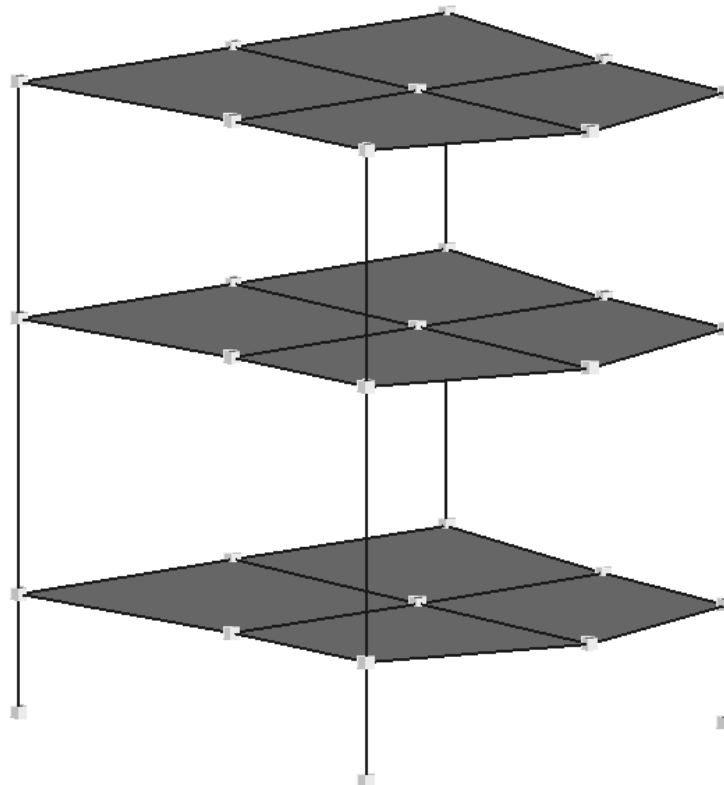

Figure 2. Rack's wireframe for modal tests.

The rack during the tests is presented in Figure 3, while figures from Figure 4 to Figure 7 show some particulars of sensors installation.



Figure 3. Golia rack during modal tests.

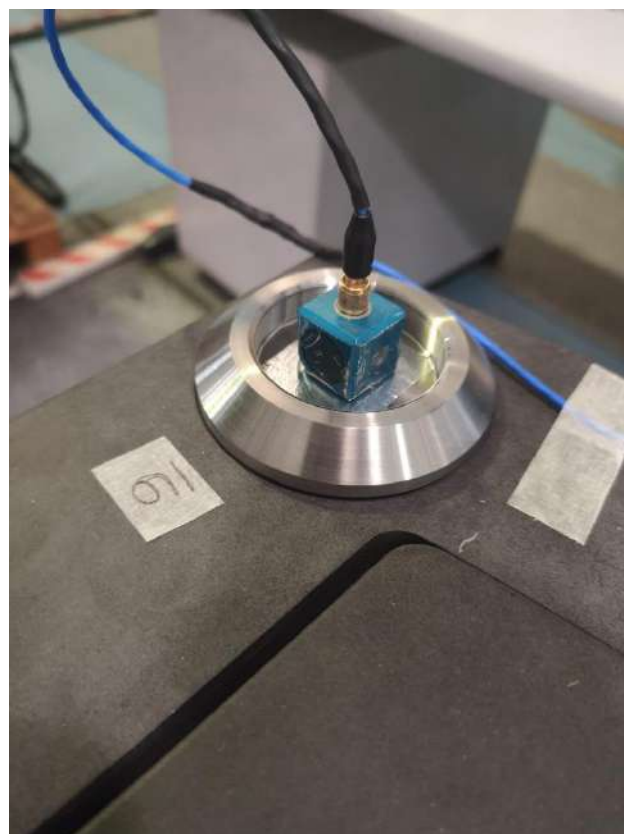

Figure 4. Golia rack during modal tests – Point 9.



Figure 5. Golia rack during modal tests – Point 10.



Figure 6. Golia rack during modal tests – Point 21.

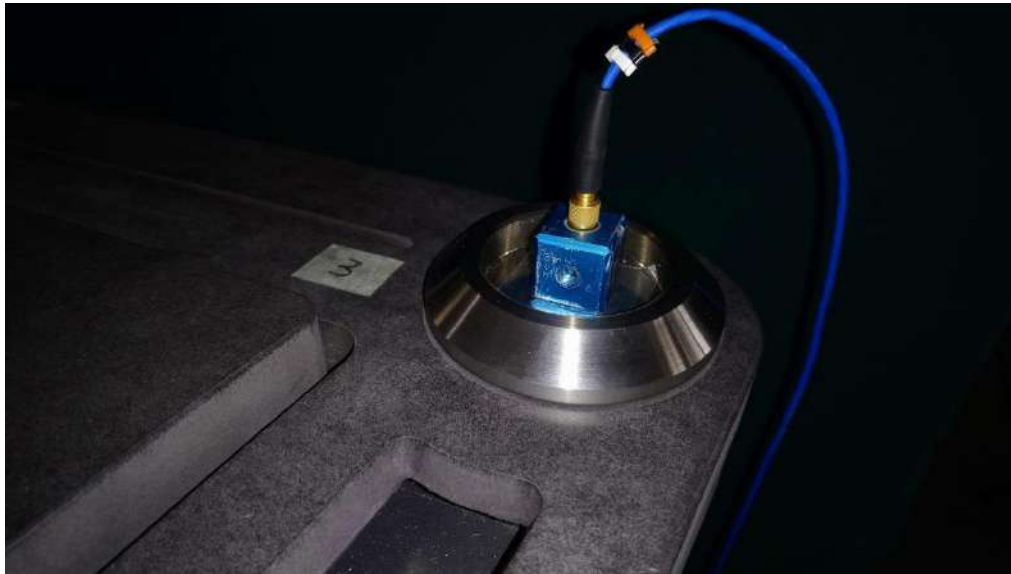

Figure 7. Golia rack during modal tests – Point 3.

Following tests are performed:

1. Tests on unloaded rack.
2. Tests on rack loaded up to 75 kg.

Results are presented in the following.

2.2 Results

Tests on unloaded rack.

These tests are performed on the rack without any additional weight, as shown in Figure 8.

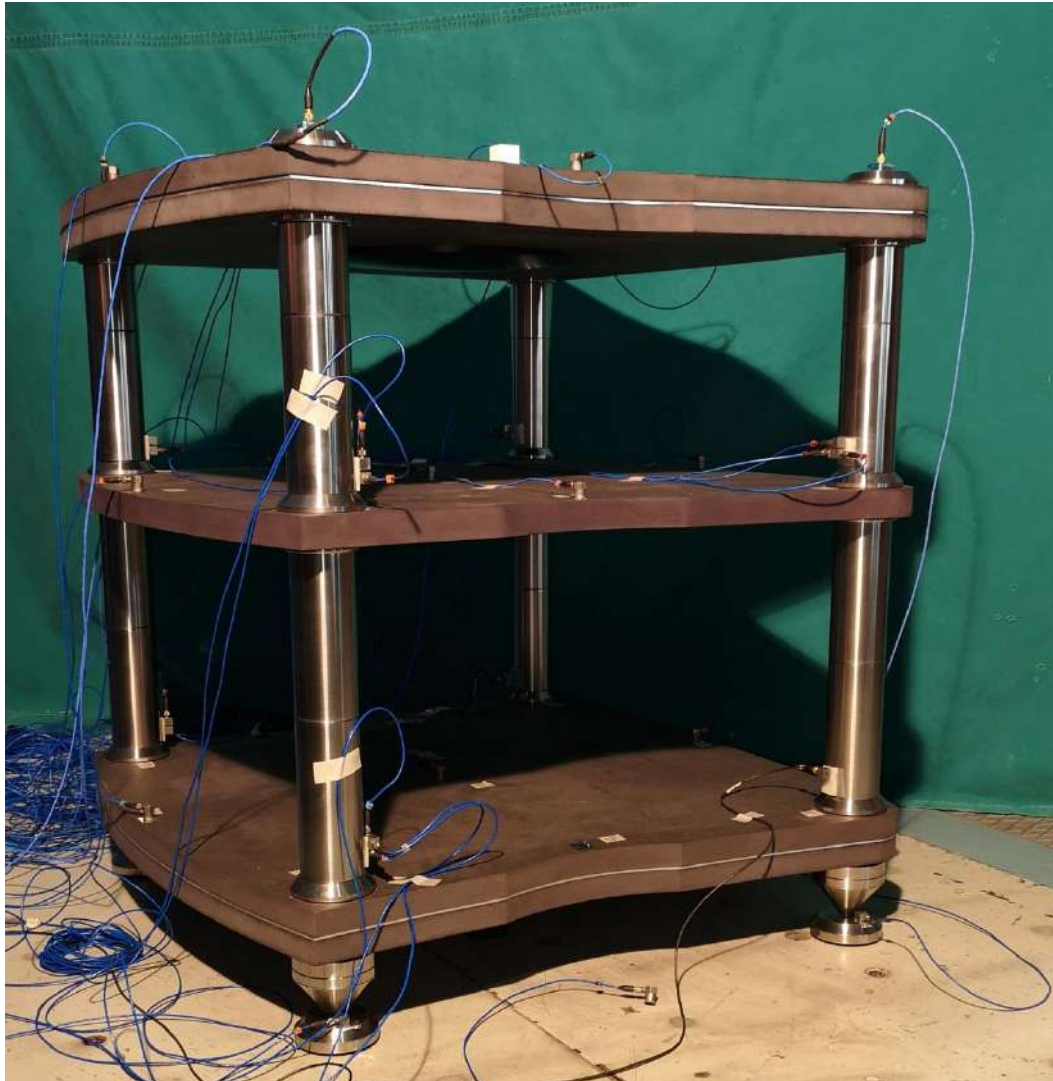

Figure 8. Unloaded Golia rack during modal tests.

Modal frequencies and corresponding damping up to 2000 Hz are resumed in Table 1.



Mode ID	Frequency [Hz]	Damping [%]
1	8,714	2,25
2	12,511	2,88
3	33,316	12,86
4	36,793	5,71
5	44,364	4,54
6	57,143	5,2
7	76,496	2,5
8	83,018	3,79
9	113,737	1,27
10	139,387	1,57
11	161,386	1,38
12	181,388	2,8
13	281,421	2,43
14	300,456	4,21
15	310,257	1,19
16	374,404	1,26
17	490,18	2,61
18	539,574	1,31
19	735,873	2,04
20	790,702	1,29
21	933,453	1,41
22	1043,09	1,46
23	1270,35	1,85
24	1540,93	1,6
25	1623,28	2,58
26	1727,55	2,02
27	1793,46	1,86
28	1840,03	1,37
29	1966,2	0,55

Table 1. Resonance frequencies and damping measured on the unloaded rack.

Modal shapes of the first six modes are reported in the figures from Figure 9 to Figure 14.

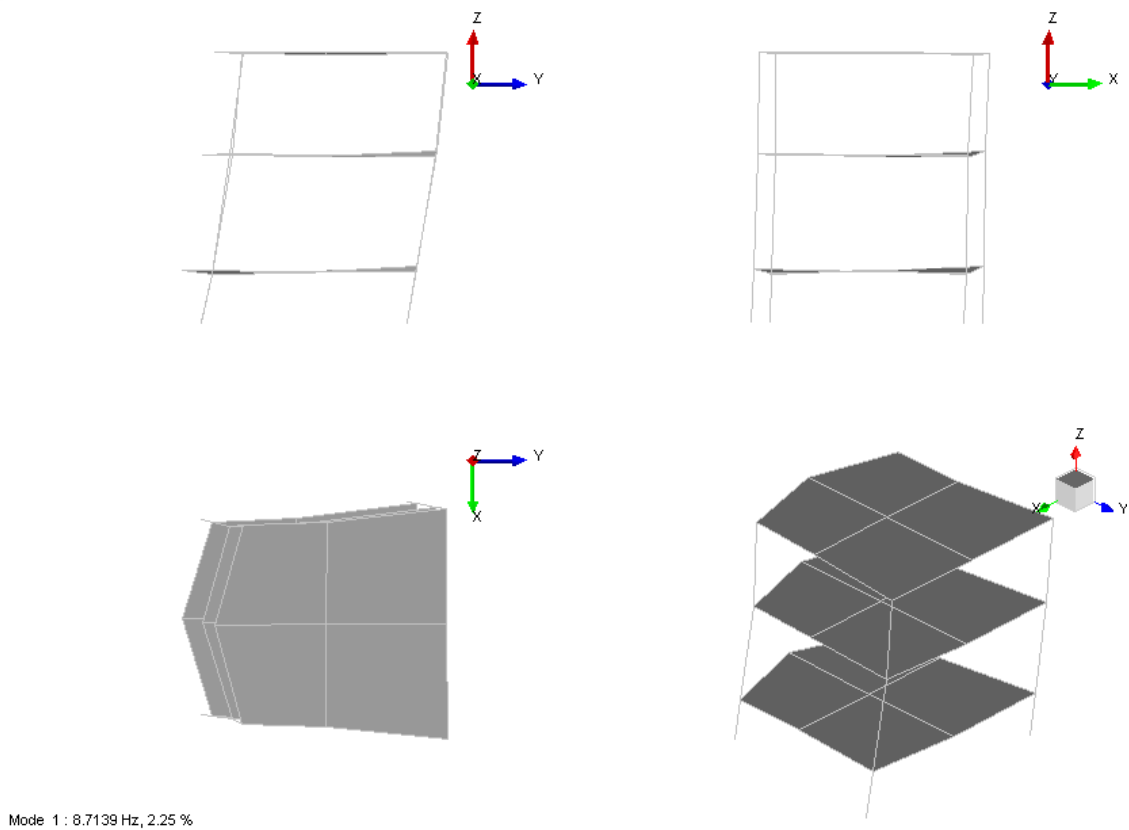

Figure 9. Mode 1 – Unloaded rack.

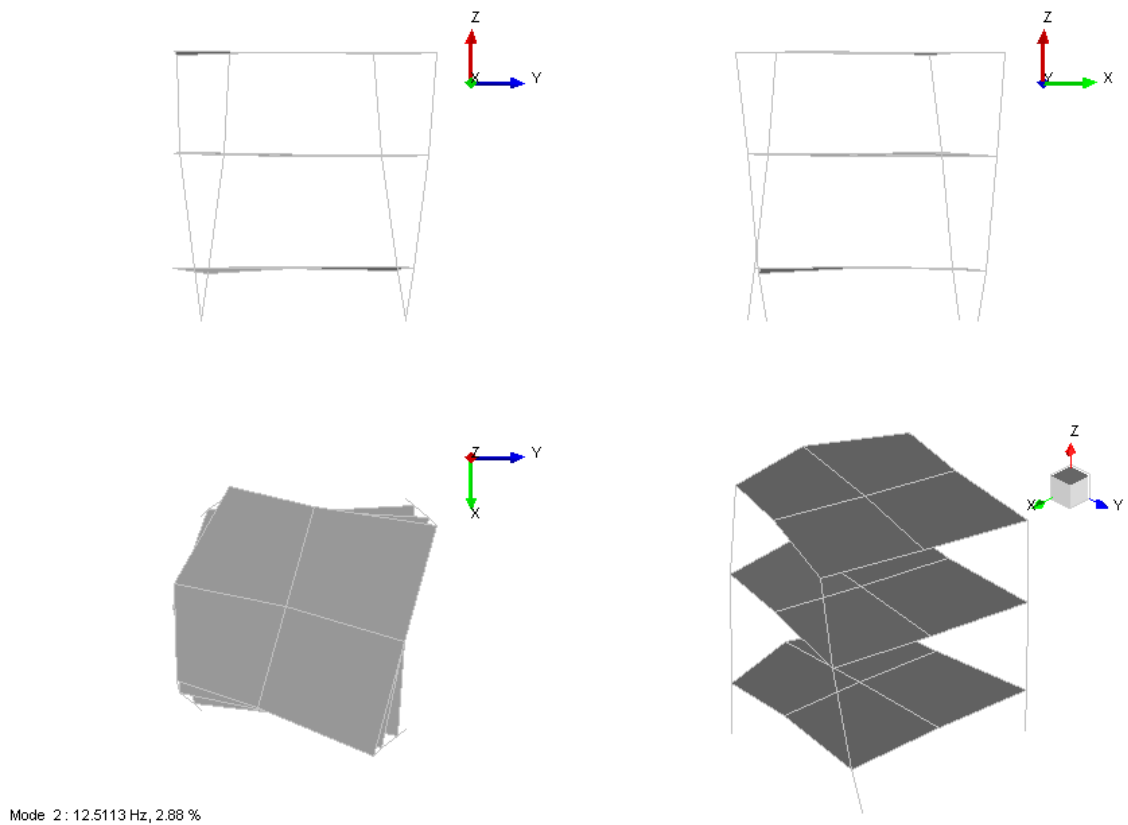

Figure 10. Mode 2 – Unloaded rack.

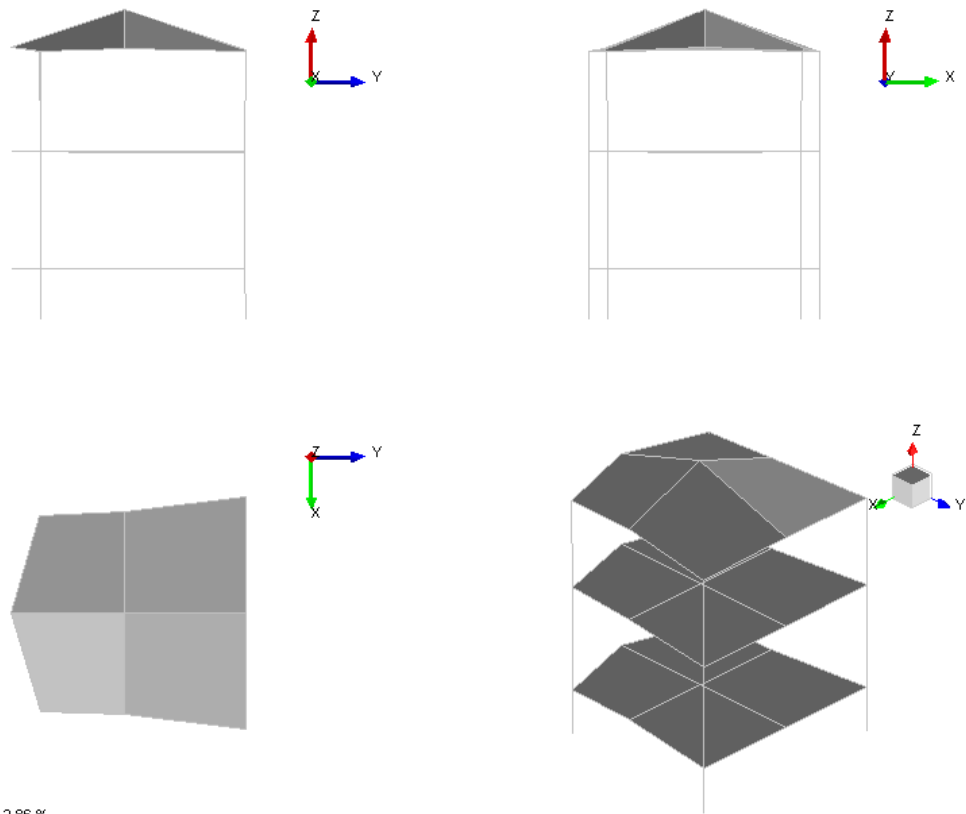

Figure 11. Mode 3 – Unloaded rack.

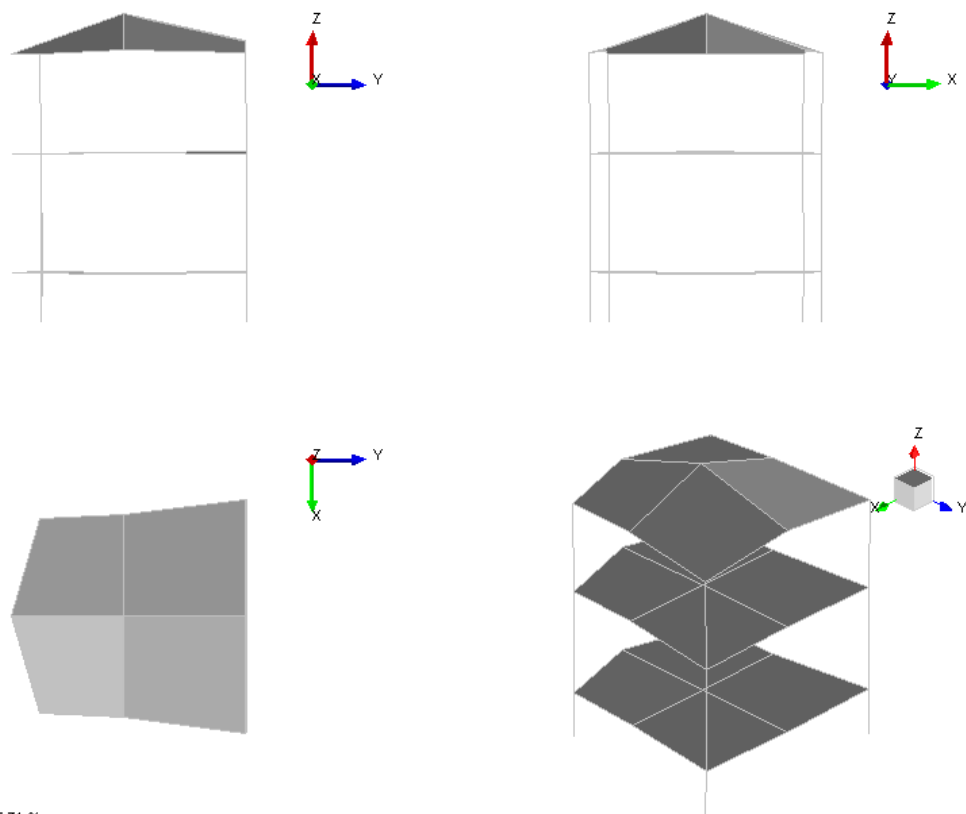

Figure 12. Mode 4 – Unloaded rack.

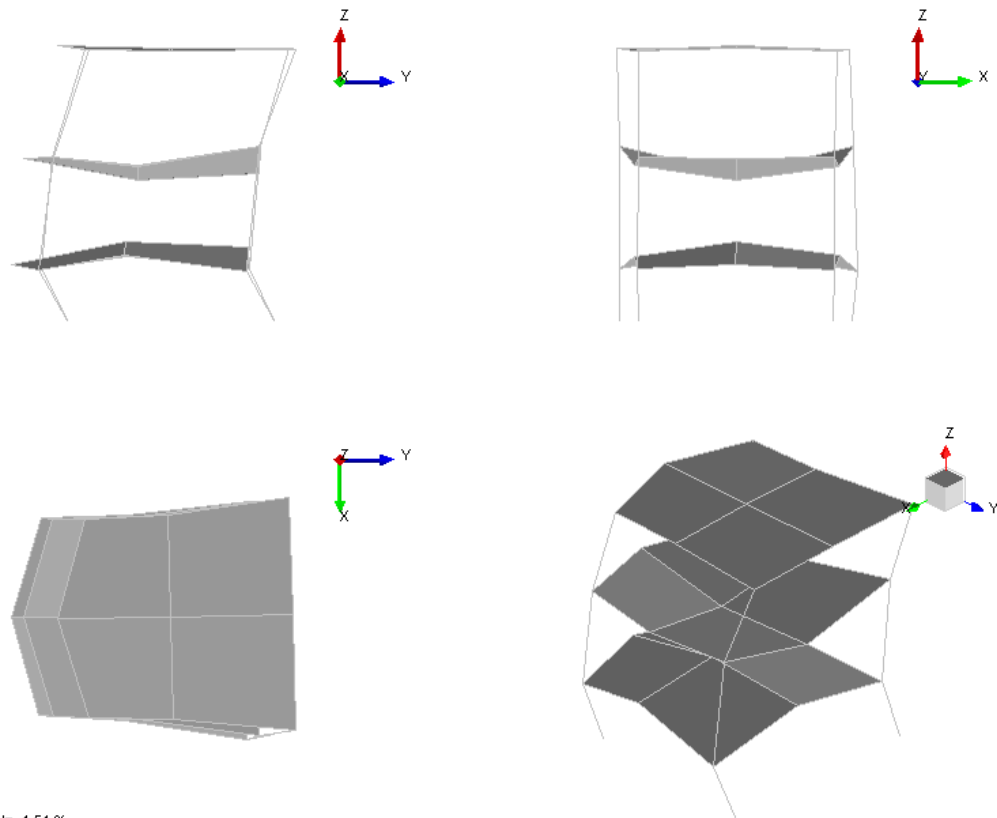

Figure 13. Mode 5 – Unloaded rack.

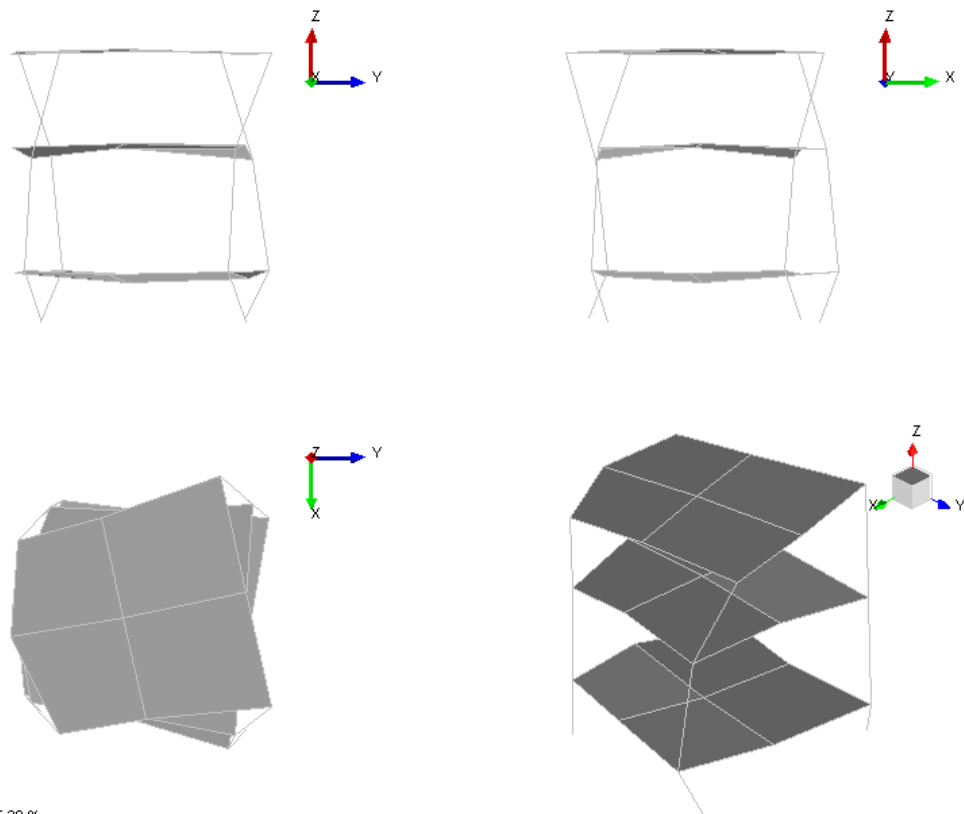

Figure 14. Mode 6 – Unloaded rack.

Tests on loaded rack

These tests are performed loading each shelf of the rack with 30 kg, as shown in Figure 15.

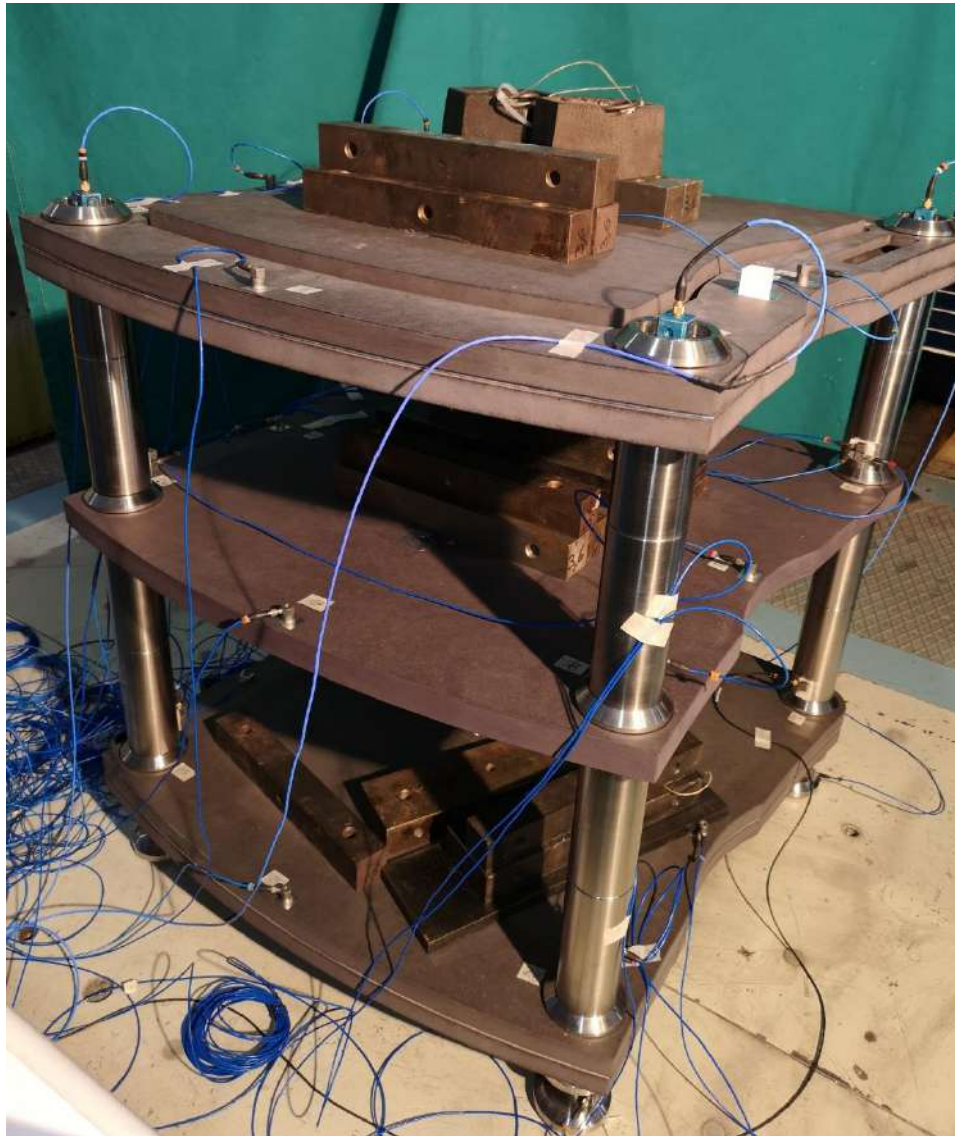

Figure 15. Loaded Golia rack during modal tests.

Modal frequencies and corresponding damping up to 2000 Hz are resumed in Table 2.



Mode ID	Frequency [Hz]	Damping [%]
1	6,684	2,41
2	11,932	2,95
3	23,185	10,36
4	31,437	2,26
5	42,212	2,95
6	54,053	5,3
7	62,202	4,22
8	71,999	7,55
9	77,577	5,94
10	123,473	5,78
11	142,525	3,99
12	162,87	3,58
13	196,214	4,49
14	271,719	4,3
15	376,858	4,48
16	521,614	6,47
17	614,357	2,86
18	684,918	2,09
19	811,302	2,91
20	848,746	2,9
21	930,449	2,59
22	1041,507	3,69
23	1157,005	2,29
24	1259,34	1,38
25	1390,455	2,66
26	1482,498	4,88
27	1691,115	1,86
28	1872,582	3,15
29	1991,502	0,68

Table 2. Resonance frequencies and damping measured on the loaded rack.

Modal shapes of the first five modes are reported in the figures from Figure 16 to Figure 20.

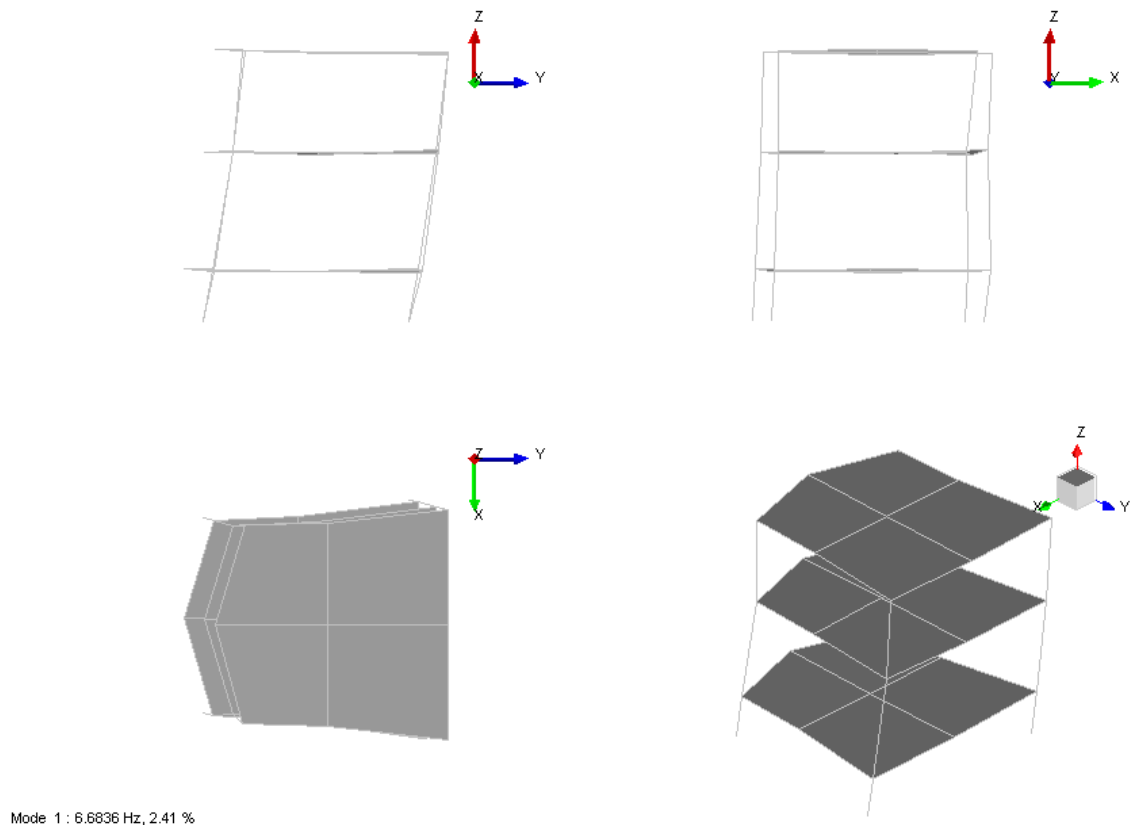

Figure 16. Mode 1 – Loaded rack.

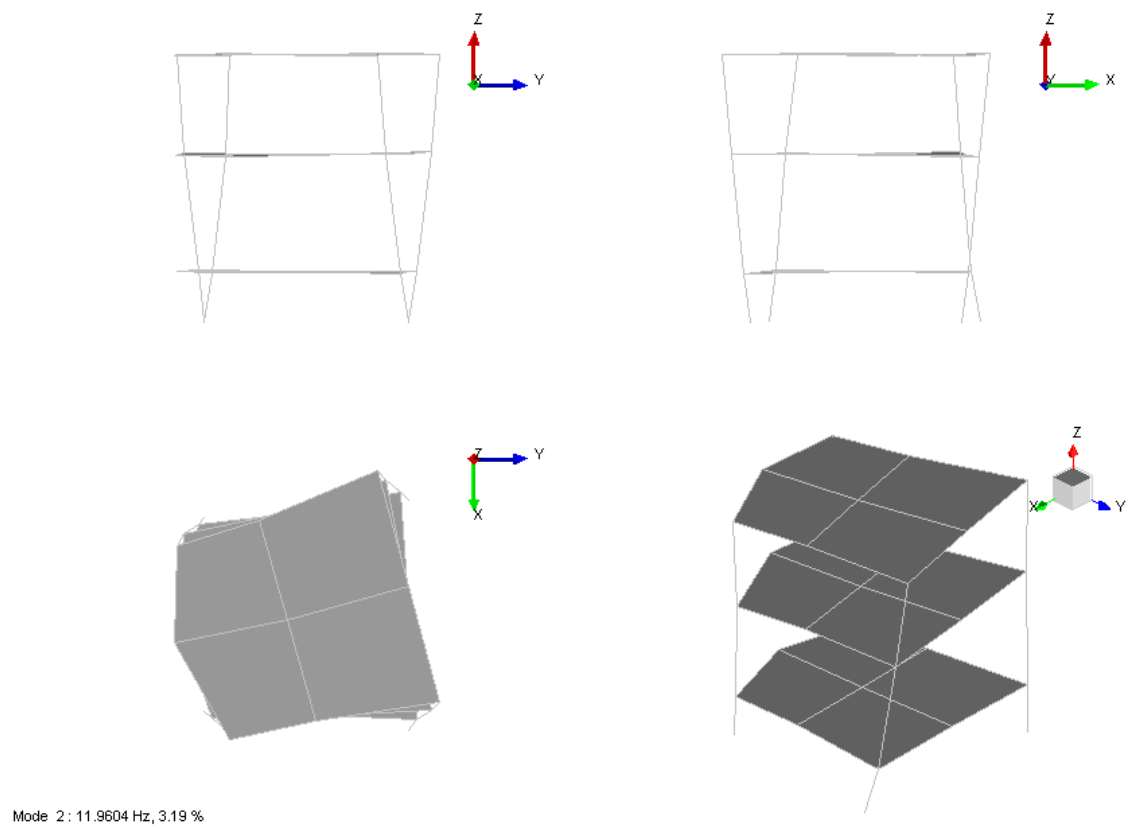

Figure 17. Mode 2 – Loaded rack.

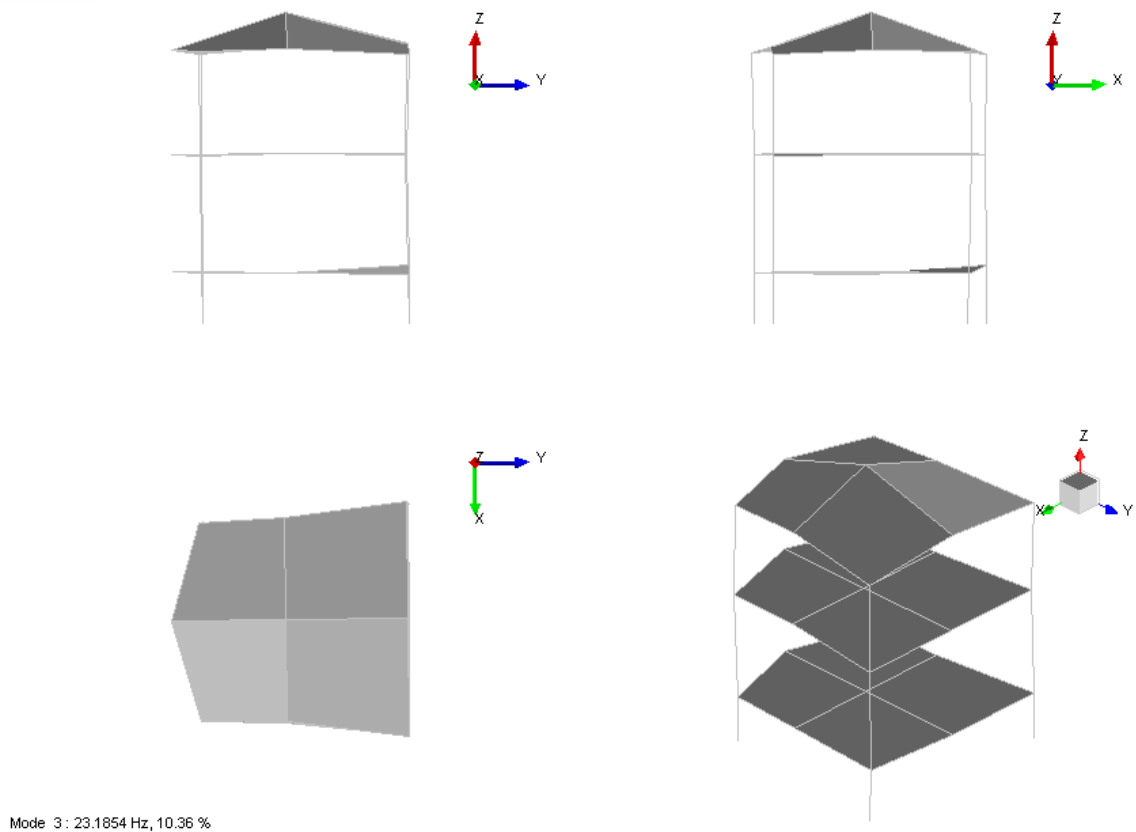

Figure 18. Mode 3 – Loaded rack.

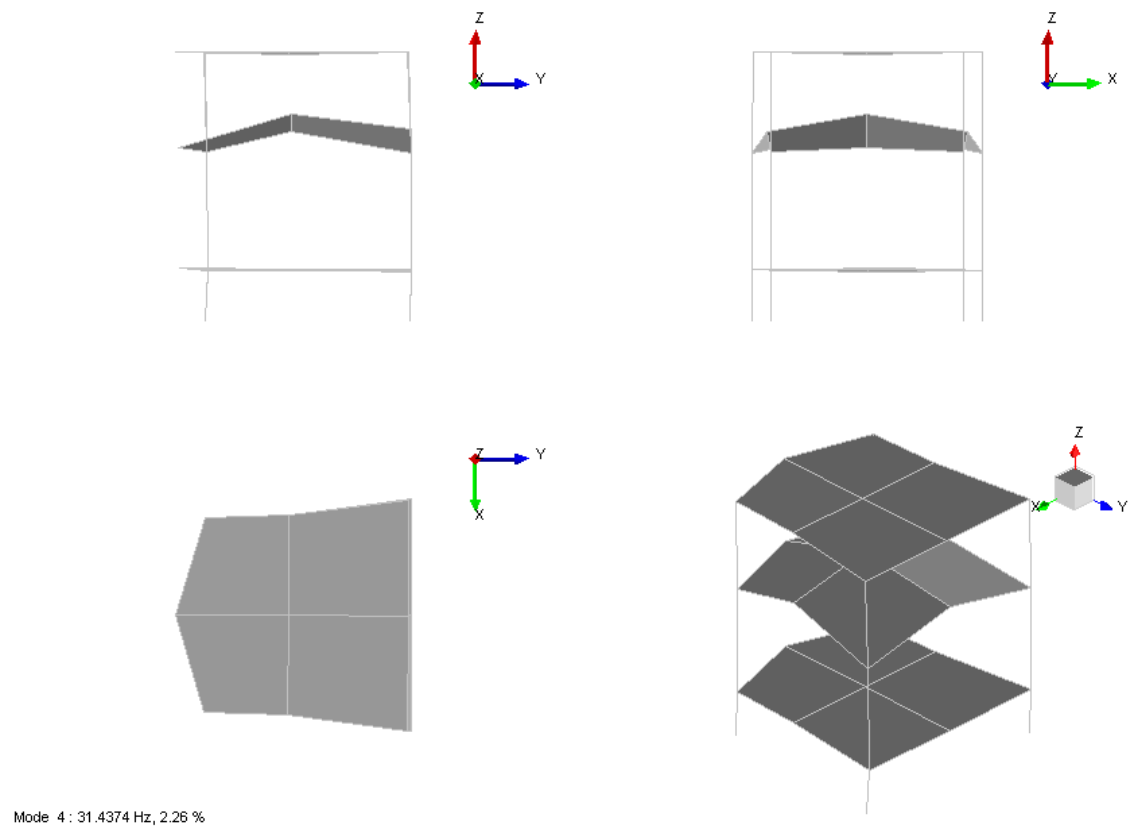

Figure 19. Mode 4 – Loaded rack.

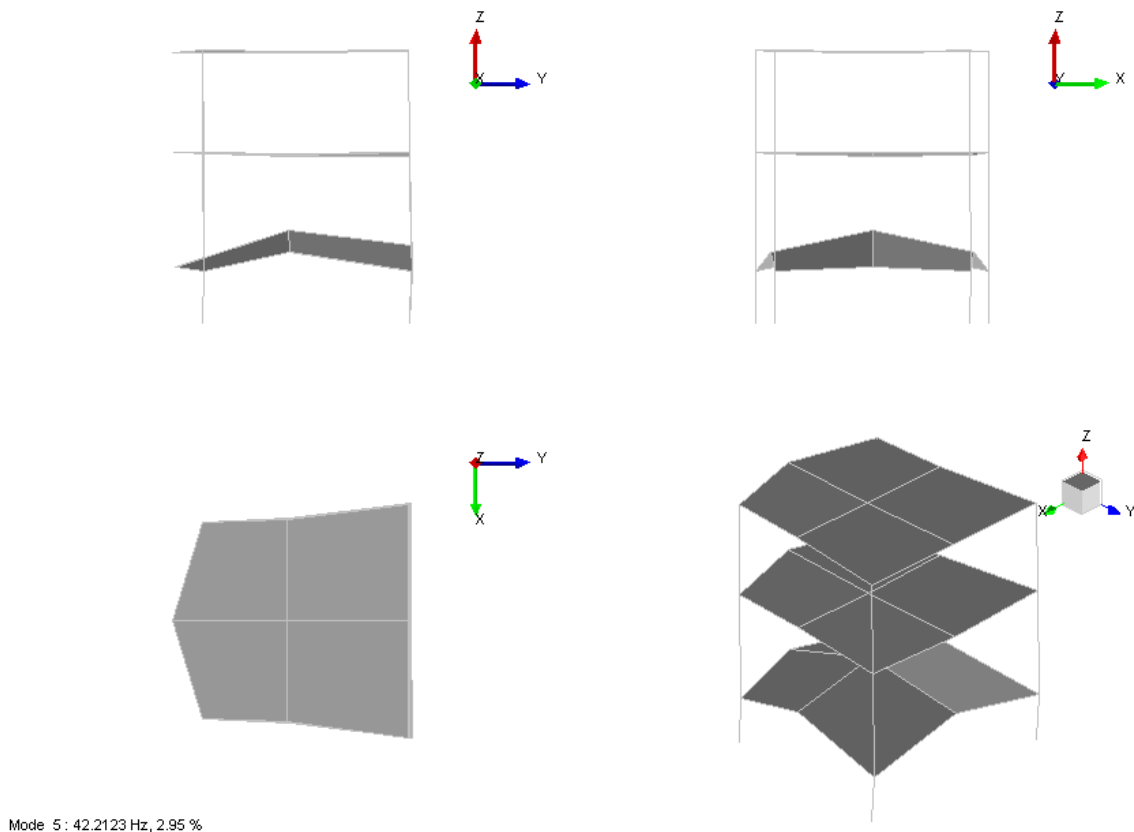

Figure 20. Mode 5 – Loaded rack.

3. *Static tests*

3.1 *Experimental setup*

Two static tests are performed:

3. Top shelf loading.
4. Middle shelf loading.

Both tests are performed using calibrated weights to load the structure from 0 kg to 75 kg and vice-versa.

Two Nippon Automation LAS-8010V laser sensors are used, with measuring range equal to $100 \text{ mm} \pm 40 \text{ mm}$, resolution of $50 \text{ }\mu\text{m}$ and response time of 50 ms.

In the test 1 it is decided to measure both the shortening of the central point of the loaded shelf and the shortening of one column; in test 2 only the shortening of the of the central point of the loaded shelf is measured.

Figures from Figure 21 to Figure 25 show pictures of the rack during static tests.



Figure 21. Test 1 – Measurement of the central point.

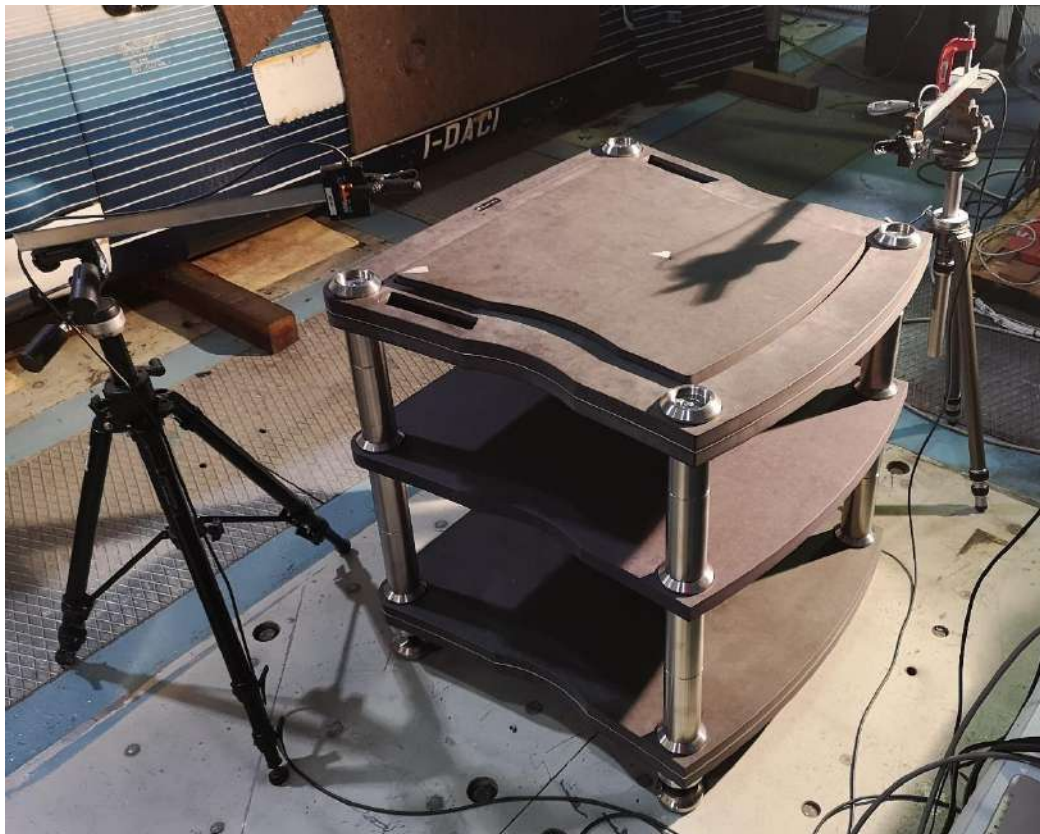

Figure 22. Test 1 – Measurement of the corner point.



Figure 23. Test 1 – Measurement of the corner point - Zoom.

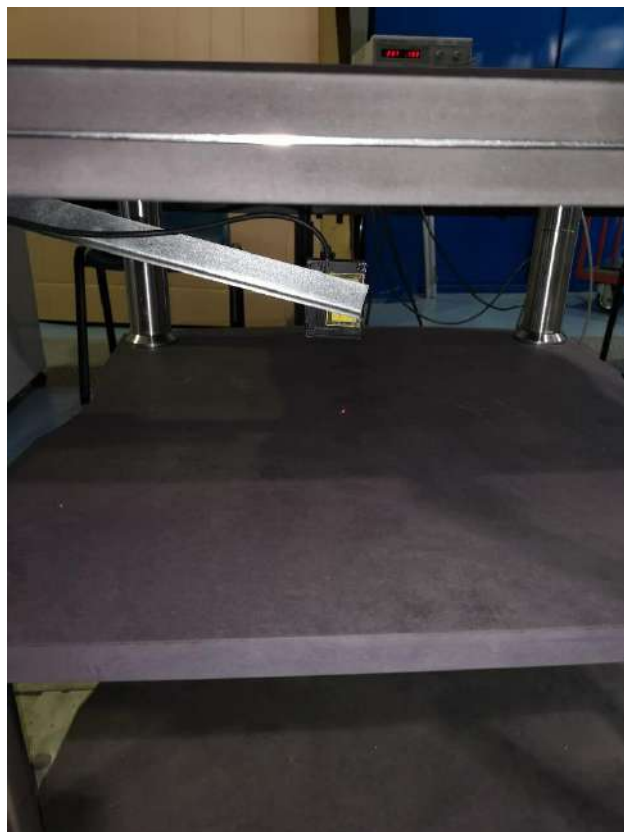

Figure 24. Test 2 – Measurement of the central point.



Figure 25. Test 2 – Measurement of the central point – loading process.

3.2 Results

Obtained results are presented in the graphs from Figure 26 to Figure 28 and summarized in Table 3.

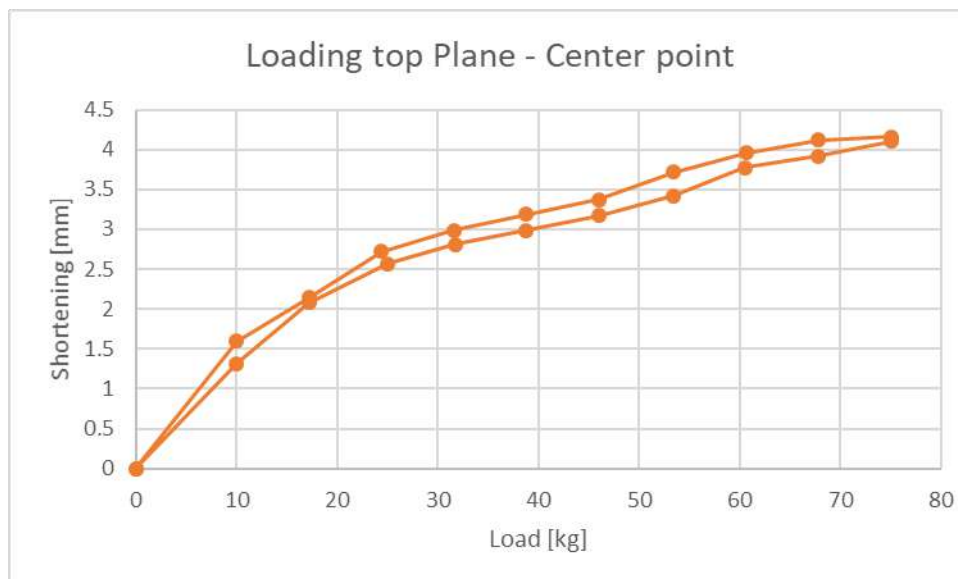

Figure 26. Test 1 – Shortening of central point as function of applied load.

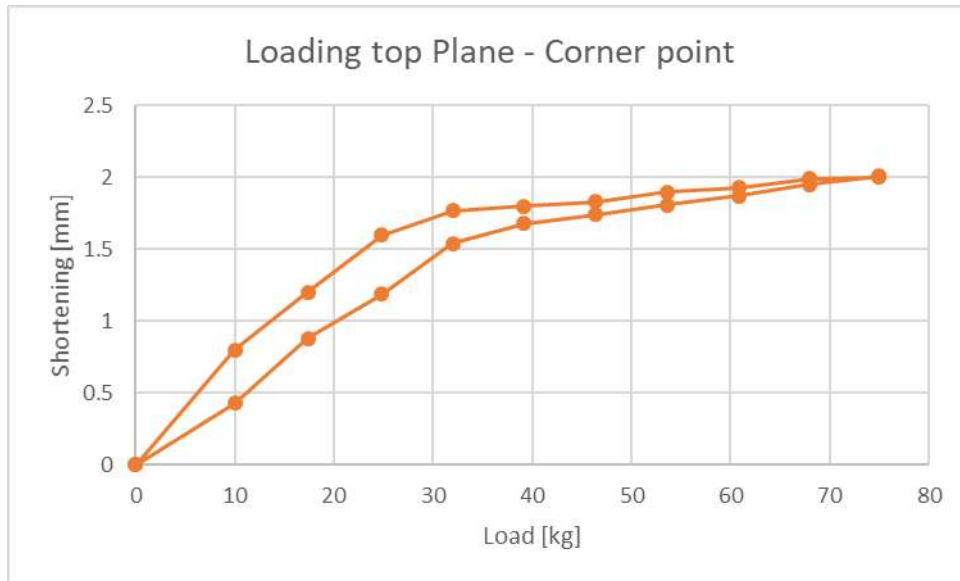

Figure 27. Test 1 – Shortening of corner point as function of applied load.

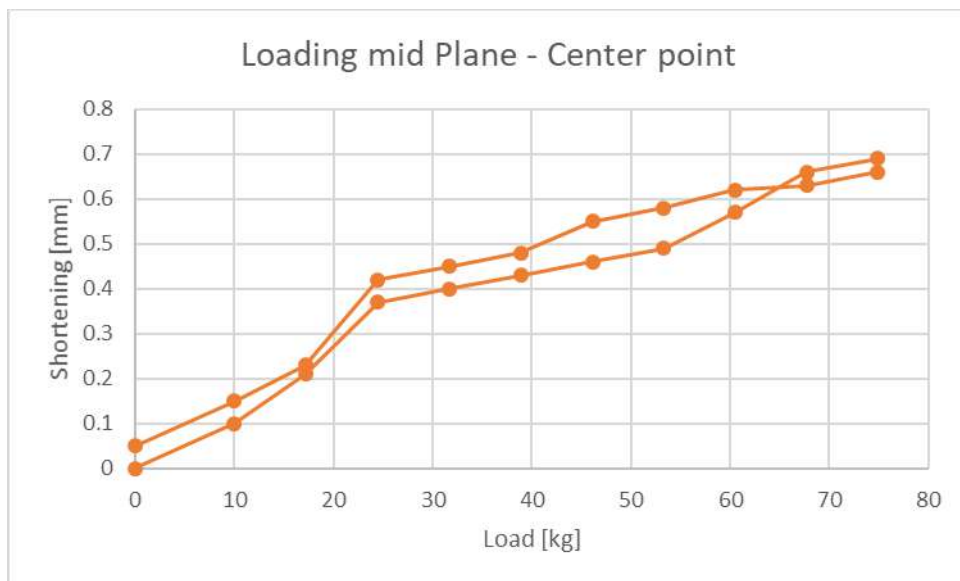

Figure 28. Test 2 – Shortening of central point as function of applied load.

Test ID	Maximum load [kg]	Maximum shortening [mm]	Measuring point
1	75.0	4.16	Centre of top shelf
1	75.0	2.01	Rack's corner
2	74.9	0.69	Centre of middle shelf

Table 3. Static test results.